



DELTA SAMA JAYA SDN. BHD. (DSSB)

(Company No. 500276-W)

(Registered with Ministry of Finance, Tenaga Nasional Berhad (TNB), CIDB, KTMB, Telekom (TM), etc.)



CABLE LADDER AND TRAY SYSTEM



Tab 3

No. 23G & 23M, DSSB Building, Jalan Perdana 6/8, Pandan Perdana,
55300 Kuala Lumpur, Malaysia
Tel: +603-9282 4007, 03 - 9281 3778; Fax: +603 - 9287 0705

Website: www.substation.com.my

and

Website: www.cablecleat.com.my

Email: samajaya@substation.com.my (General)
Email: accounts@substation.com.my , sales@substation.com.my (Sales)

CABLE LADDER

DSSB CABLE LADDER SYSTEM

MAIN STANDARD COMPONENTS

DSSB

- | | |
|-----------------------------------|--------------------------------------|
| ① Cable Ladder - Straight Section | ⑫ Straight Splice Plate |
| ② 90° Elbow | ⑬ Vertical Adjustable Splice Plate |
| ③ Tee | ⑭ Horizontal Adjustable Splice Plate |
| ④ Unequal Tee | ⑮ Drop Out |
| ⑤ Reducer -RH | ⑯ End Plate |
| ⑥ Reducer -LH | ⑰ Cover for Straight Ladder |
| ⑦ Inside Riser | ⑱ Cover Clips |
| ⑧ Outside Riser | ⑲ Separator |
| ⑨ Cross | ⑳ Ladder to Box Connector |
| ⑩ Unequal Cross | |
| ⑪ Straight Reducer | |

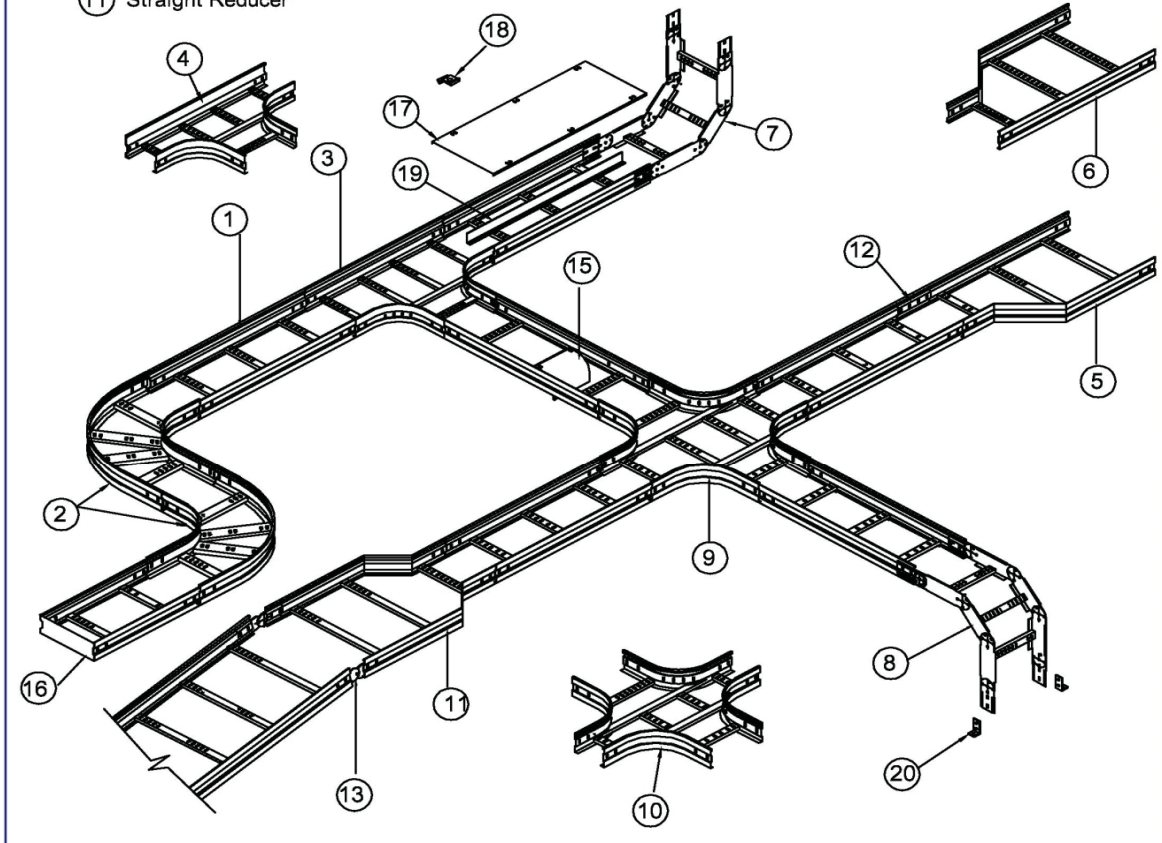

CABLE LADDER

DSSB CABLE LADDER SYSTEM

DSSB

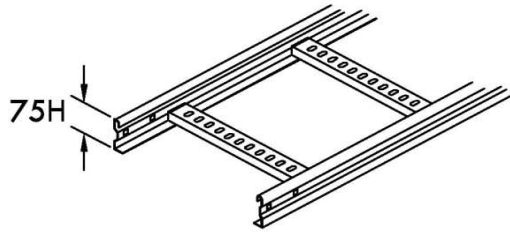

DSSB 75

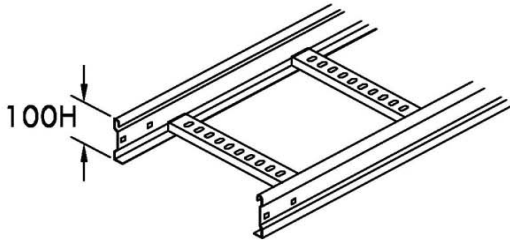

DSSB 100

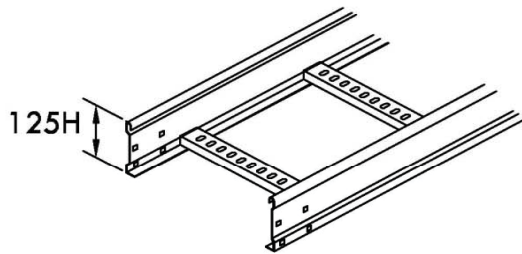

DSSB 125

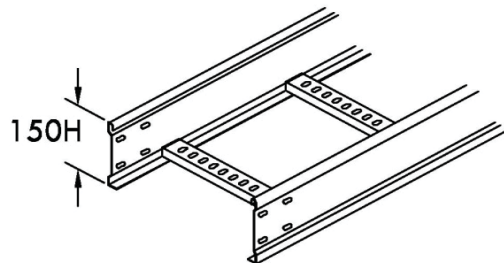

DSSB 150

CABLE LADDER

DSSB 100 CABLE LADDER

DSSB100 Medium Duty and DSSB100 Heavy Duty Cable Ladder DSSB

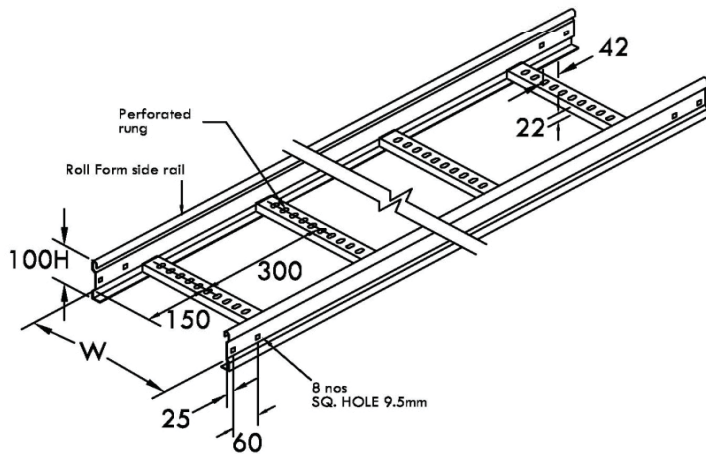

DSSB 100 Medium Duty
 Stock length : 3M , (6M available)
 G = Carbon Steel , Hot Dipped Galvanized
 to BS EN ISO 1461 : 1991
 DG - Corten 'A' Extra thick Galv'd
 1.5mm = Material thickness

W	Unit Weight (kg)	Art No:
		G
150	14.5	DSSB00/150/3/1.5/G
300	16.3	DSSB100/300/3/1.5/G
450	18.2	DSSB100/450/3/1.5/G
500	18.9	DSSB100/500/3/1.5/G
600	22	DSSB100/600/3/1.5/G
750	24.5	DSSB100/750/3/1.5/G
900	27.5	DSSB100/900/3/1.5/G

DSSB100 Heavy Duty
 Stock length : 3M , (6M available)
 G = Carbon Steel , Hot Dipped Galvanized
 to BS EN ISO 1461 : 1991
 DG - Corten 'A' Extra thick Galv'd
 2.0mm = Material thickness

W	Unit Weight (kg)	Art No:
		G
150	18.3	DSSB100/150/3/2/G
300	20.6	DSSB100/300/3/2/G
450	22.8	DSSB100/450/3/2/G
500	25.3	DSSB100/500/3/2/G
600	27.3	DSSB100/600/3/2/G
750	30	DSSB100/750/3/2/G
900	32.9	DSSB100/900/3/2/G

CABLE LADDER

90", 60", 45", 30" ELBOW

DSSB

90° ELBOW - E

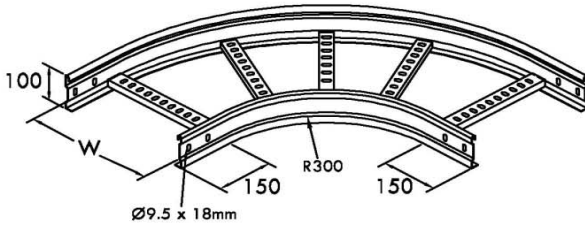

W	R	Unit Weight(kg)		Art No :	
		R300	G		
150	300	7.30	DSSB 00/E/R3/150/G		
300	300	8.20	DSSB 100/E/R3/300/G		
450	300	9.10	DSSB 100/E/R3/450/G		
600	300	10.90	DSSB 100/E/R3/600/G		
700	300	12.00	DSSB 100/E/R3/700/G		
800	300		DSSB 100/E/R3/800/G		
900	300	13.20	DSSB 100/E/R3/900/G		
1000	300		DSSB 100/E/R3/1000/G		

60° ELBOW - E60

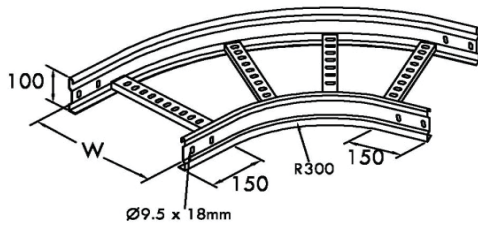

W	R	Unit Weight(kg)		Art No :	
		R300	G		
150	300	6.40	DSSB 100/E60/R3/150/G		
300	300	7.20	DSSB 100/E60/R3/300/G		
450	300	7.90	DSSB 100/E60/R3/450/G		
600	300	9.60	DSSB 100/E60/R3/600/G		
700	300	10.50	DSSB 100/E60/R3/700/G		
800	300		DSSB 100/E60/R3/800/G		
900	300	11.50	DSSB 100/E60/R3/900/G		
1000	300		DSSB 100/E60/R3/1000/G		

45° ELBOW - E45

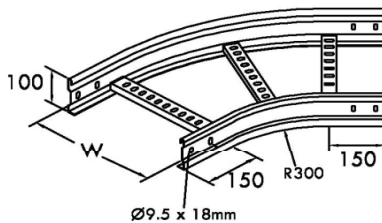

W	R	Unit Weight(kg)		Art No :	
		R300	G		
150	300	5.50	DSSB 100/E45/R3/150/G		
300	300	6.20	DSSB 100/E45/R3/300/G		
450	300	6.80	DSSB 100/E45/R3/450/G		
600	300	8.20	DSSB 100/E45/R3/600/G		
700	300	9.00	DSSB 100/E45/R3/700/G		
800	300		DSSB 100/E45/R3/800/G		
900	300	9.90	DSSB 100/E45/R3/900/G		
1000	300		DSSB 100/E45/R3/1000/G		

30° ELBOW - E30

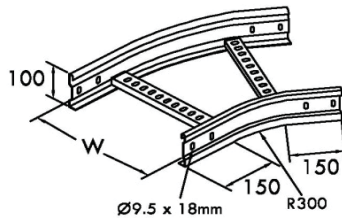

W	R	Unit Weight(kg)		Art No :	
		R300	G		
150	300	4.60	DSSB 100/E30/R3/150/G		
300	300	5.20	DSSB 100/E30/R3/300/G		
450	300	5.70	DSSB 100/E30/R3/450/G		
600	300	6.80	DSSB 100/E30/R3/600/G		
700	300	7.50	DSSB 100/E30/R3/700/G		
800	300		DSSB 100/E30/R3/800/G		
900	300	8.30	DSSB 100/E30/R3/900/G		
1000	300		DSSB 100/E30/R3/1000/G		

CABLE LADDER

TEE, UNEQUAL TEE, CROSS AND UNEQUAL CROSS

DSSB

TEE - T

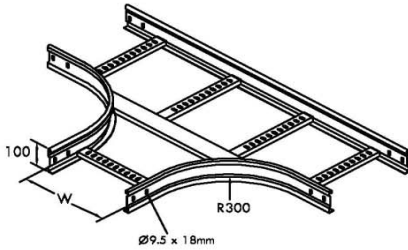

W	R	Unit Weight (kg)	Art no :
			G
150	300	12.00	DSSB 100/T/R3/150/G
300	300	13.00	DSSB 100/T/R3/300/G
450	300	15.00	DSSB 100/T/R3/450/G
600	300	17.00	DSSB 100/T/R3/600/G
700	300	19.00	DSSB 100/T/R3/700/G
800	300		DSSB 100/T/R3/800/G
900	300	22.00	DSSB 100/T/R3/900/G
1000	300		DSSB 100/T/R3/1000/G

UNEQUAL TEE - UT

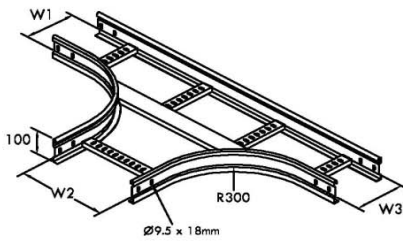

W1	W2	W3	Unit Weight (kg)	Art No:
				G
600	300	600	16.00	DSSB 100/UT/R3/300/600/300/G

CROSS - X

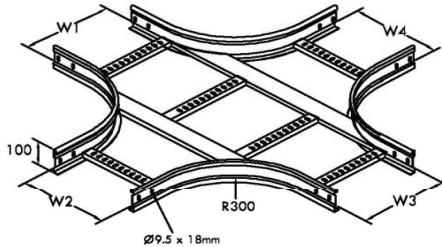

W	R	Unit Weight (kg)	Art no :
			G
150	300	15.00	DSSB 100/X/R3/150/G
300	300	16.00	DSSB 100/X/R3/300/G
450	300	18.00	DSSB 100/X/R3/450/G
600	300	22.00	DSSB 100/X/R3/600/G
700	300	24.00	DSSB 100/X/R3/700/G
800	300		DSSB 100/X/R3/800/G
900	300	25.00	DSSB 100/X/R3/900/G
1000	300		DSSB 100/X/R3/1000/G

UNEQUAL CROSS - UX

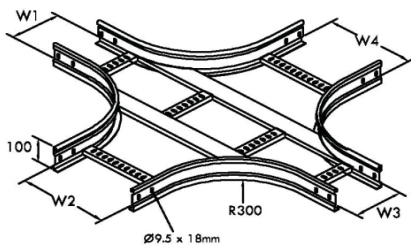

W1	W2	W3	W4	Unit Weight (kg)	Art no :
					G
600	300	600	300	21.00	DSSB 100/UX/R3/600/300/600/300/G

CABLE LADDER

REDUCER, RIGHT REDUCER, LEFT

DSSB

CENTER REDUCER - CR

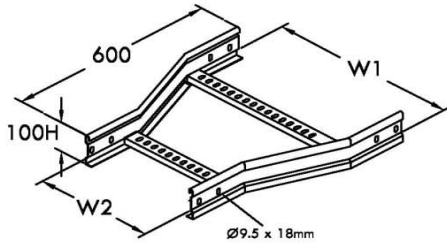

W1	W2	Unit Weight (kg)	Art no :
			G
300	150	5.00	DSSB100/CR/300/150/G
450	300	7.00	DSSB100/CR/450/300/G
600	450	8.00	DSSB100/CR/600/450/G
700	600	9.00	DSSB100/CR/700/600/G
900	700	10.00	DSSB100/CR/900/700/G

LEFT REDUCER - LR

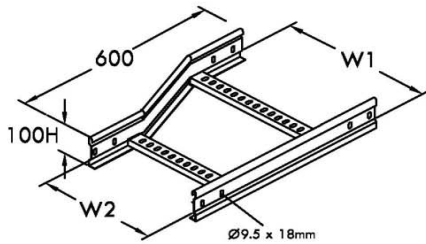

W1	W2	Unit Weight (kg)	Art no :
			G
300	150	5.00	DSSB100/LR/300/150/G
450	300	7.00	DSSB100/LR/450/300/G
600	450	8.00	DSSB100/LR/600/450/G
700	600	9.00	DSSB100/LR/700/600/G
900	700	10.00	DSSB100/LR/900/700/G

RIGHT REDUCER - RR

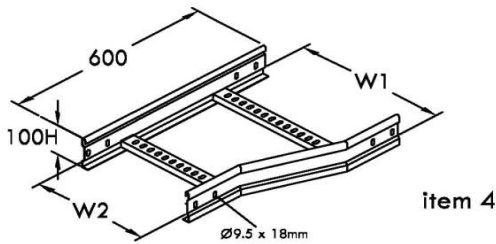

W1	W2	Unit Weight (kg)	Art no :
			G
300	150	5.00	DSSB100/RR/300/150/G
450	300	7.00	DSSB100/RR/450/300/G
600	450	8.00	DSSB100/RR/600/450/G
700	600	9.00	DSSB100/RR/700/600/G
900	700	10.00	DSSB100/RR/900/700/G

CABLE LADDER

RISER

DSSB

45° OUTSIDE RISER - OR45

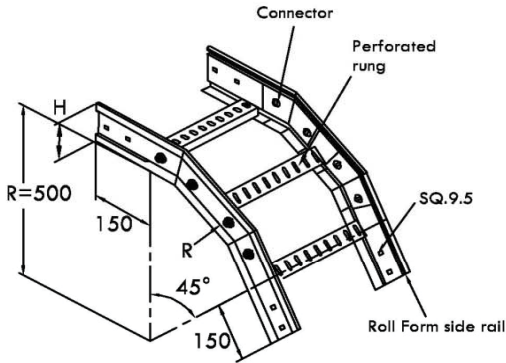

W	R	Unit Weight (kg)	Art No:	
			G	
150	500	4.86	DSSB100/OR45/R5/150/G	
300	500	5.58	DSSB100/OR45/R5/300/G	
450	500	6.18	DSSB100/OR45/R5/450/G	
600	500	7.38	DSSB100/OR45/R5/600/G	
700	500	8.10	DSSB100/OR45/R5/700/G	
900	500	8.88	DSSB100/OR45/R5/900/G	

45° INSIDE RISER - IR45

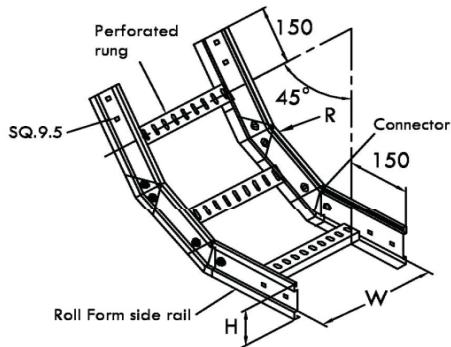

W	R	Unit Weight (kg)	Art No:	
			G	
150	500	4.86	DSSB100/IR45/R5/150/G	
300	500	5.58	DSSB100/IR45/R5/300/G	
450	500	6.18	DSSB100/IR45/R5/450/G	
600	500	7.38	DSSB100/IR45/R5/600/G	
700	500	8.10	DSSB100/IR45/R5/700/G	
900	500	8.88	DSSB100/IR45/R5/900/G	

SPLICE PLATE, VERT. ADJ. CPLICE

DSSB

SPLICE PLATE

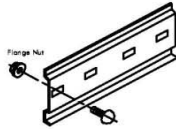
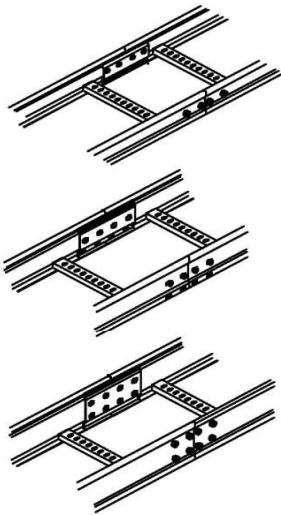

Art No:	Wt/20pcs
SP -DSSB100	

4 SETS
M8 x 16

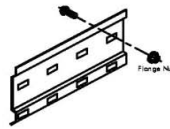

Art No:	Wt/20pcs
SP -DSSB125	

8 SETS
M8 x 16

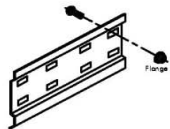

Art No:	Wt/20pcs
SP -DSSB150	

8 SETS
M8 x 16

VERT.ADJUSTABLE SPLICE PLATE

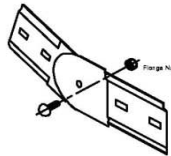
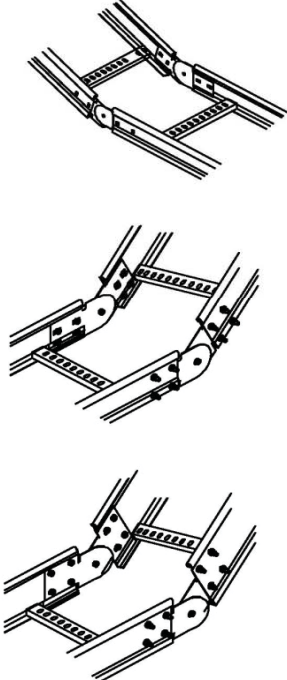

Art No:	Wt/20pcs
VASP-DSSB100	

8 SETS
M8 x 16

1 SETS
M10 x 15

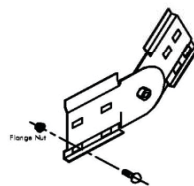

Art No:	Wt/20pcs
VASP -DSSB125	

8 SETS
M8 x 16

1 SETS
M10 x 12

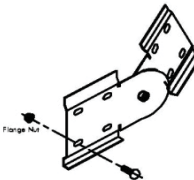

Art No:	Wt/20pcs
VASP -DSSB150	

8 SETS
M8 x 16

1 SETS
M10 x 12

CABLE LADDER

HOLD DOWN

DSSB

Hold Down Type A

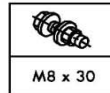
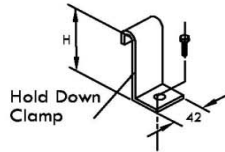
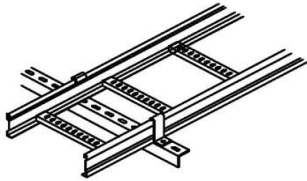

Part No:	H
HDCA -DSSB100	99
HDCA -DSSB125	124
HDCA -DSSB150	149

Hold Down Type B & D

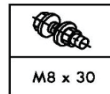
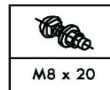
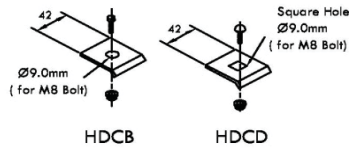
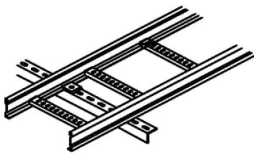

Part No :	Wt/100pcs
HDCB	
HDCD	

Expansion Guide D

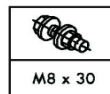
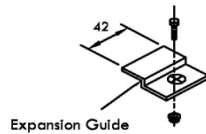
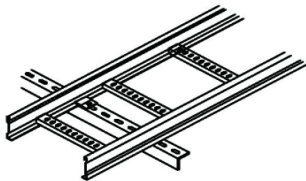

Part No :	Wt/100pcs
HDCE	

CABLE LADDER

HOLD DOWN

DSSB

Hold Down Type A

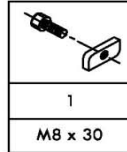
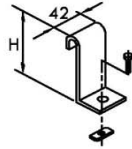
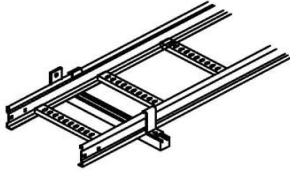

Art No:	H	Wt/100pcs
HDCA - DSSB 100	99	
HDCA - DSSB 125	124	
HDCA - DSSB 150	149	

Hold Down Type B

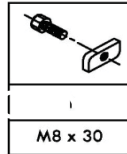
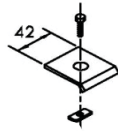
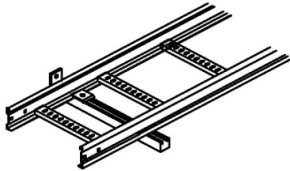

Art No:	Wt/100pcs
HDCB	

Hold Down Type C

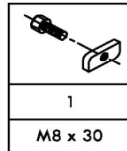
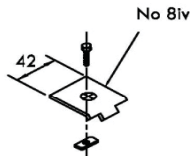
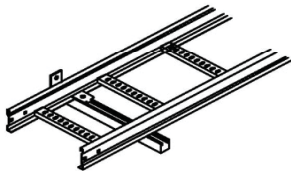

Art No:	Wt/100pcs
HDCC	

Expansion Guide D

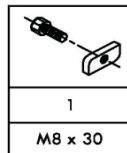
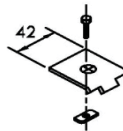
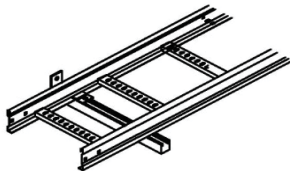

Art No:	Wt/100pcs
HDCE	

HOLD DOWN

Hold Down Type F

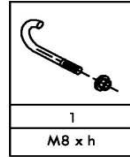
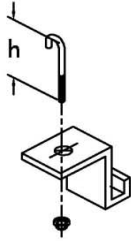
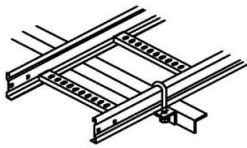

Art No:	h	W/t 100
HDCF - DSSB 100	130	
HDCF - DSSB 125	155	
HDCF - DSSB 150	175	

Hold Down Type G

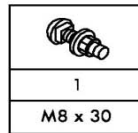
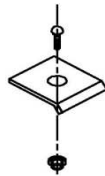
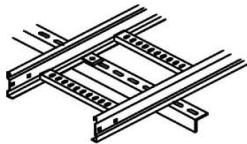

Art No:	W/t 100
HDCG	

Hold Down Type H

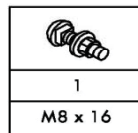
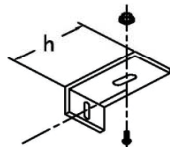
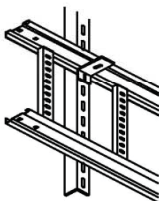

Art No:	H	W/t 100
HDCH - DSSB 100	95	
HDCH - DSSB 125	120	
HDCH - DSSB 150	145	

Hold Down Type J

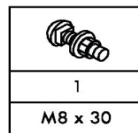
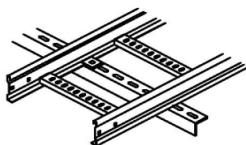

Art No:	W/t 100
HDCJ	

SEPARATOR FOR ELBOW

DSSB

SEPARATOR FOR ELBOW

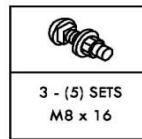
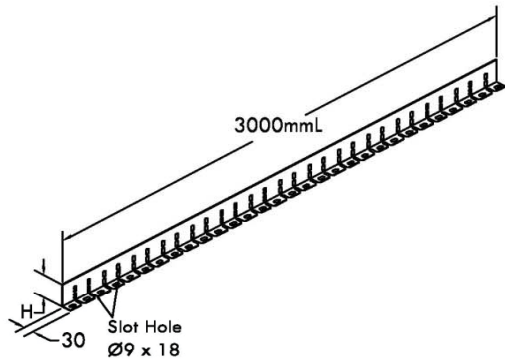

Standard Length : 3M

Art No:	H	Wt/m kg
SEE-100	78	1.4
SEE-125	98	1.7
SEE-150	120	2.0

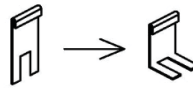
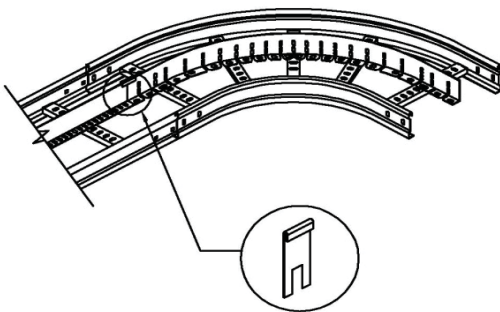

Separator Connector

Art No:	a
SC-100	115
SC-125	140
SC-150	165

CABLE LADDER

SEPARATOR FOR RISER

DSSB

SEPARATOR FOR OUTSIDE RISER - SEOR

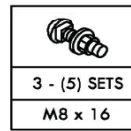
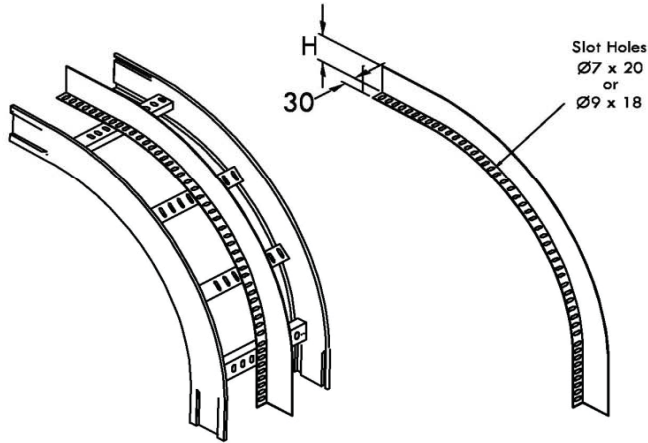

Art No :	H	Wt(kg)
SEOR - 100	78	
SEOR - 125	98	
SEOR - 150	120	

SEPARATOR FOR INSIDE RISER - SEIR

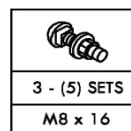
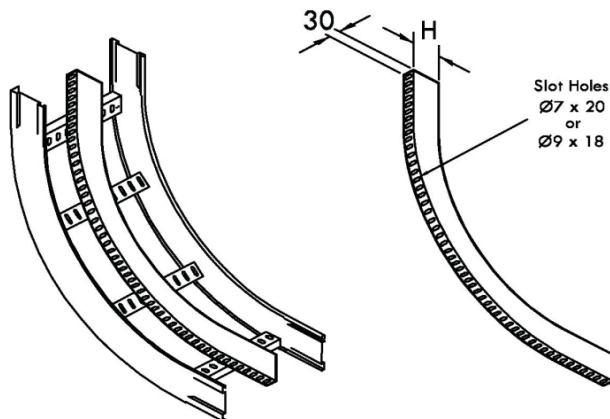

Art No :	H	Wt(kg)
SEIR - 100	78	
SEIR - 125	98	
SEIR - 150	120	

CABLE LADDER

BONDING JUMPER

DSSB

BONDING JUMPER - BJA

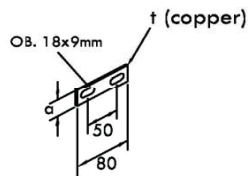
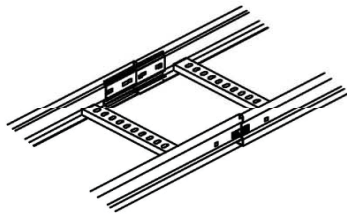

Art No	a	Thickness t (mm)	wt/100pcs.
BJA-10	25	1.0	
BJA-15	25	1.5	
BJA-20	25	2.0	

BONDING JUMPER - EB

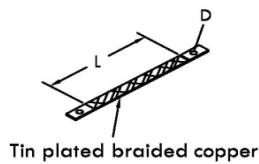
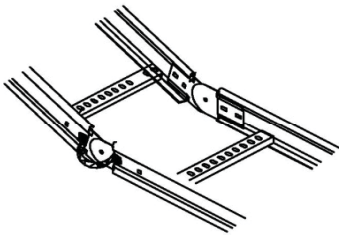

Art No	Cross Section mm ²	L	D	Current AMP	Wt/100pcs
EB6	6	150	7	45	
EB10	10	300	7	75	
EB16	16	250	9	120	
EB30	30	250	11	180	
EB50	50	300	11	250	

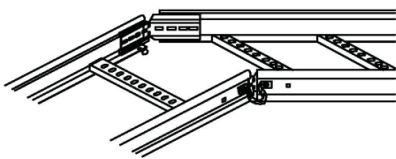

CABLE LADDER



www.substation.com.my

CABLE TRAY

RETURN FLANGE CABLE TRAY TYPE RT50

DSSB

Return Flange Cable Tray

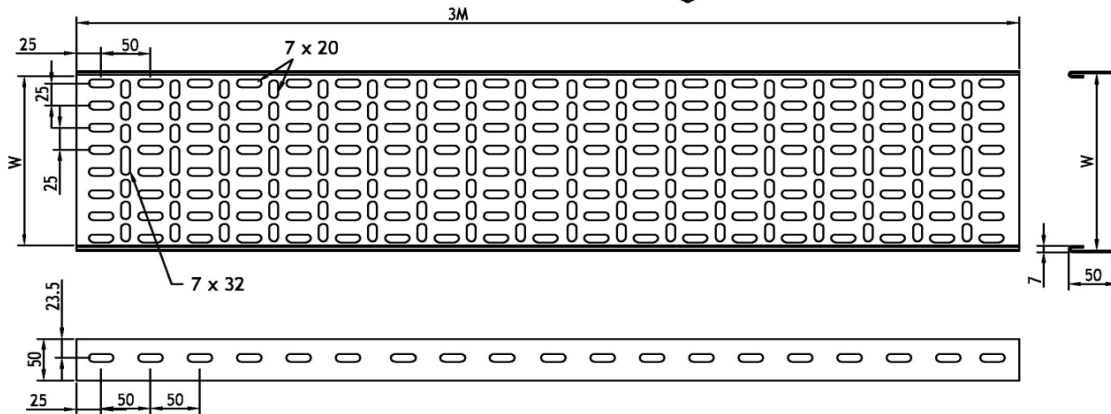
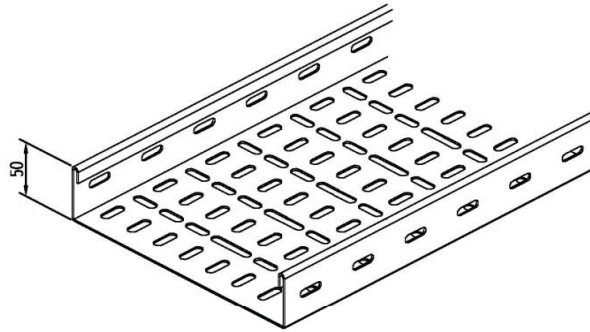

Material / Finishes

- G - Mild Steel sheet-
Hot Dipped Galvanized to BS 1461 : 1999
- DG - Corten A steel
Deep Galvanized for
added Corrosion protection
- E - EG sheet
Coated in Epoxy
- A2 - Stainless steel - SS 304
- A4 - Stainless steel - SS 316 L

Art No : Type-width	Weight (kg)
RT50 - 50	
RT50 - 75	
RT50 - 100	
RT50 - 150	
RT50 - 200	
RT50 - 300	
RT50 - 400	
RT50 - 500	
RT50 - 600	

Standard Length : 3M

CABLE TRAY

ELBOW

DSSB

30° ELBOW - E30

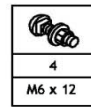
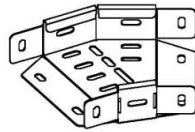
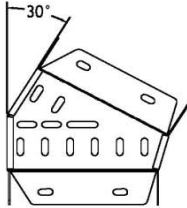

Art No.	Weight (kg)
RT50E30-50	
RT50E30-75	
RT50E30-100	
RT50E30-150	
RT50E30-200	
RT50E30-300	
RT50E30-400	
RT50E30-500	
RT50E30-600	

45° ELBOW - E45

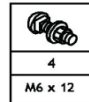
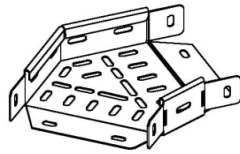
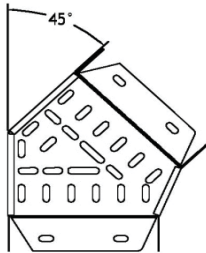

Art No.	Weight (kg)
RT50E45-50	
RT50E45-75	
RT50E45-100	
RT50E45-150	
RT50E45-200	
RT50E45-300	
RT50E45-400	
RT50E45-500	
RT50E45-600	

ELBOW - E

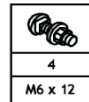
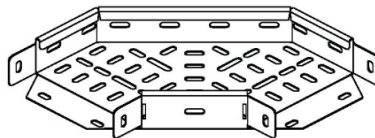
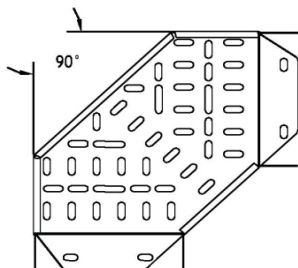

Art No.	Weight (kg)
RT50E-50	
RT50E-75	
RT50E-100	
RT50E-150	
RT50E-200	
RT50E-300	
RT50E-400	
RT50E-500	
RT50E-600	

CABLE TRAY

TEE, CROSS, CENTER REDUCER

DSSB

TEE - T

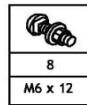
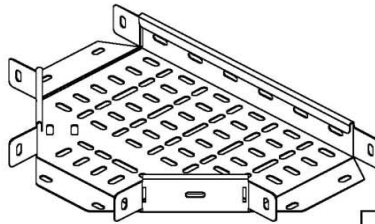
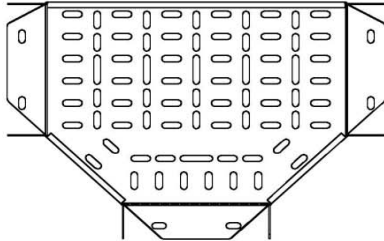

Art No.	Weight (kg)
RT50T-50	
RT50T-75	
RT50T-100	
RT50T-150	
RT50T-200	
RT50T-300	
RT50T-400	
RT50T-500	
RT50T-600	

CROSS - X

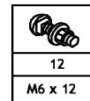
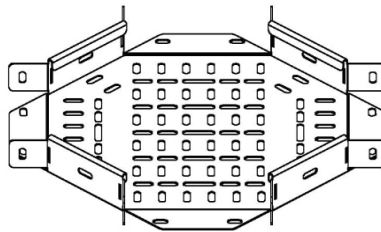
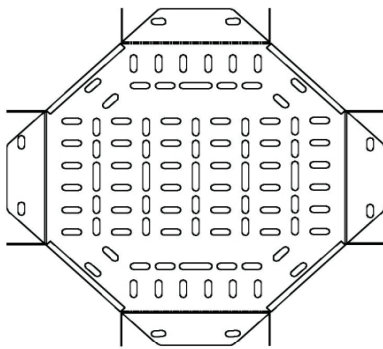

Art No.	Weight (kg)
RT50X-50	
RT50X-75	
RT50X-100	
RT50X-150	
RT50X-200	
RT50X-300	
RT50X-400	
RT50X-500	
RT50X-600	

CENTER REDUCER -CR

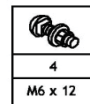
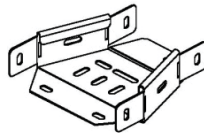
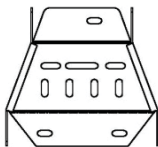

Art No.	Weight (kg)
RT50CR-50	
RT50CR75	
RT50CR-100	
RT50CR-150	
RT50CR-200	
RT50CR-300	
RT50CR-400	
RT50CR-500	
RT50CR-600	

CABLE TRAY

SPLICE PLATE

DSSB

STRAIGHT SPLICE PLATE - SP....

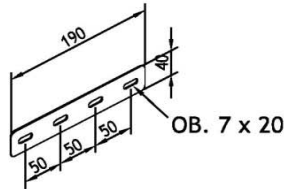
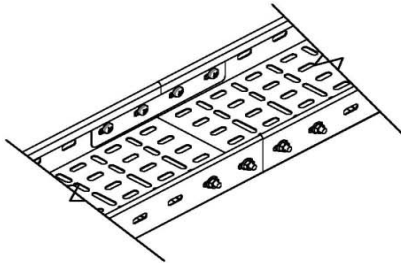

Art No:	Wt/100pcs
SPJR	

HOR.ADJUSTABLE SPLICE PLATE - HA....

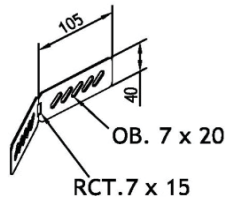
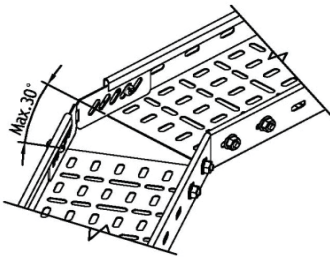

Art No:	Wt/100pcs
HAJR	

VERT.ADJUSTABLE SPLICE PLATE - VA....

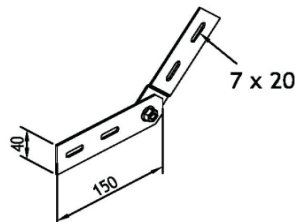
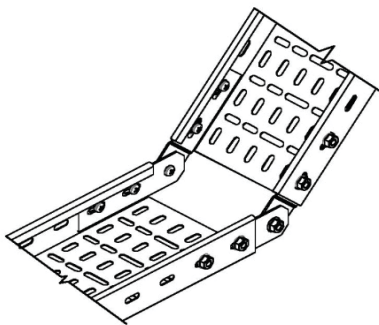

Art No:	Wt/100pcs
VAJR	

CABLE TRAY

HOLD DOWN CLIP

DSSB

HOLD DOWN CLIP Type : I

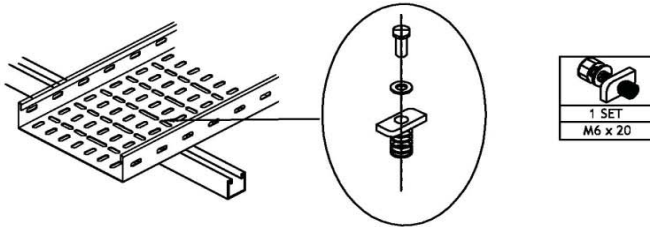

HOLD DOWN CLIP Type : II

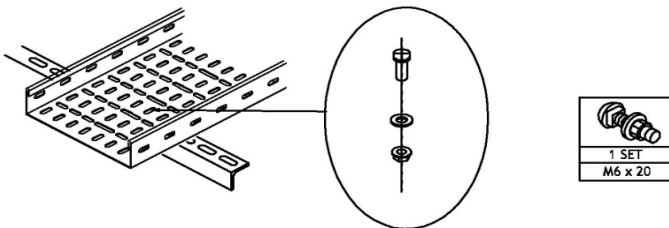

HOLD DOWN CLIP Type : HDC

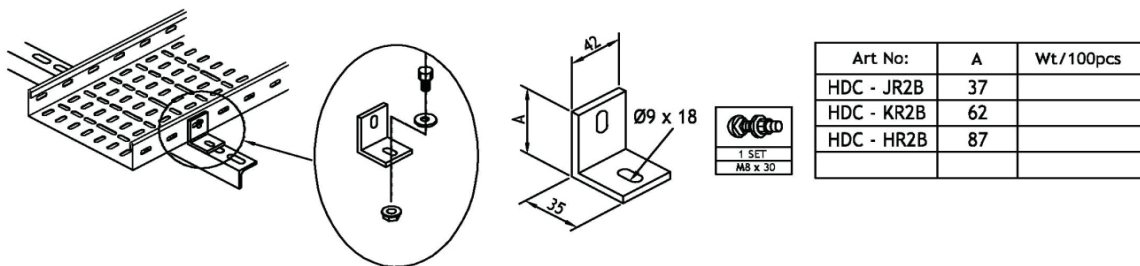

CABLE TRAY

INSIDE RISER

DSSB

INSIDE RISER - IR

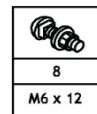
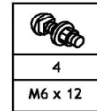
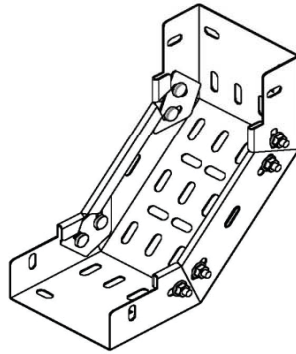
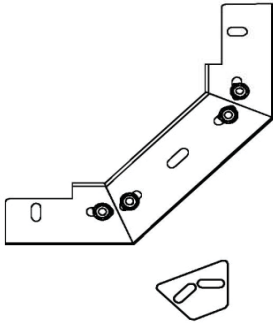

Art No.	Weight (kg)
RT50IR-50	
RT50IR-75	
RT50IR-100	
RT50IR-150	
RT50IR-200	
RT50IR-300	
RT50IR-400	
RT50IR-500	
RT50IR-600	

CABLE TRAY

ER & JR ACCESSORIES

DSSB

DROP OUT BRACKET

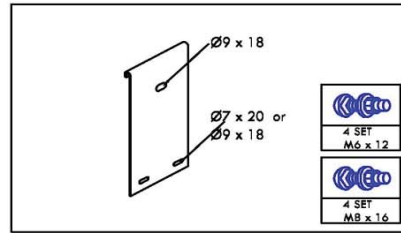
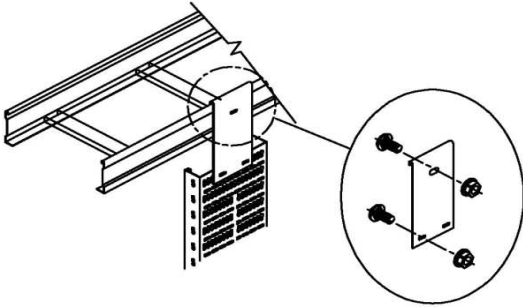

CABLE TRAY TO BOX CONNECTOR

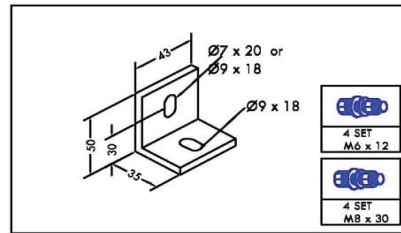
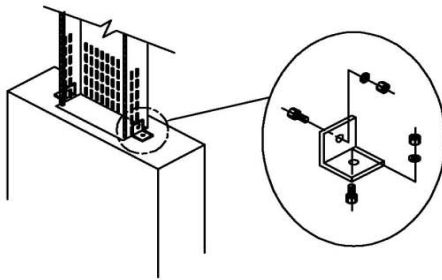

VERTICAL ADJUSTABLE FLOOR MOUNTING BRACKET

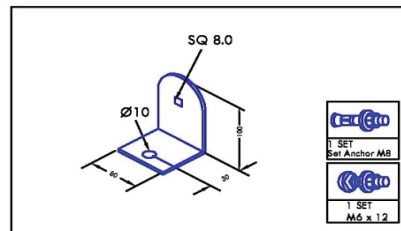
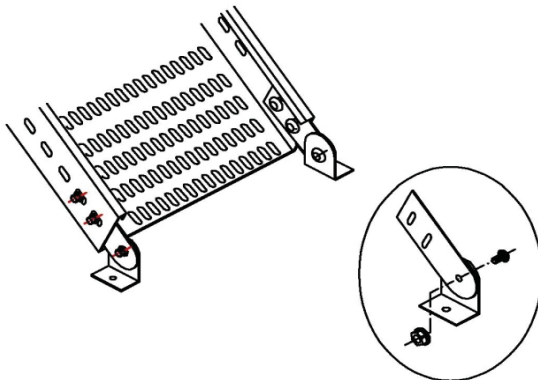

CABLE TRAY

FLEXISTRUT

DSSB

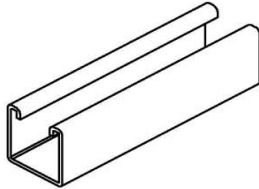

DSSB series	Material Thickness	dimension	Mass kg/m
FS100	2.5	41 x 41	2.67
FS102	2.0	41 x 41	2.14

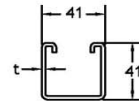

Standard length = 6m

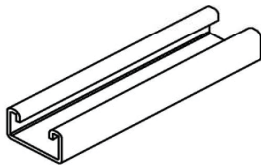

DSSB series	Material Thickness	dimension	Mass kg/m
FS300	2.5	22 x 41	
FS302	2.0	22 x 41	

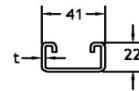

Standard length = 6m

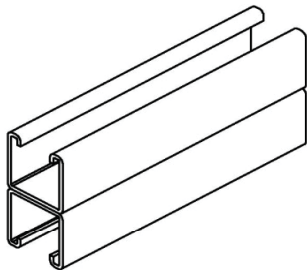

DSSB series	Material Thickness	dimension	Mass kg/m
FS120	2.5	82 x 41	
FS122	2.0	82 x 41	

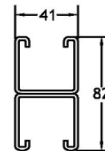

Standard length = 6m

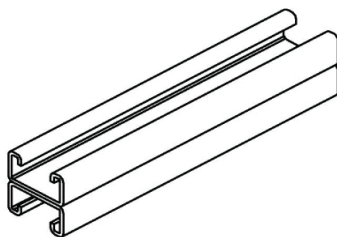

DSSB series	Material Thickness	dimension	Mass kg/m
FS320	2.5	41 x 44	
FS321	2.0	41 x 44	

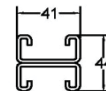

Standard length = 6m

Standard Length : 6 Meter

CABLE TRAY

FLEXISTRUT

DSSB

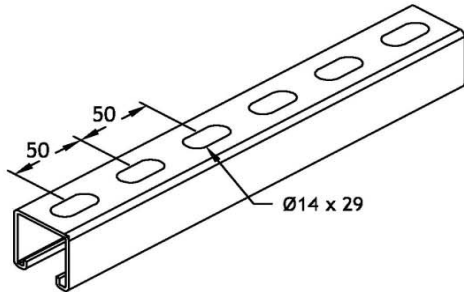

DSSB series	Material Thickness	dimension	Mass kg/m
FS100T1	2.5	41 x 41	
FS102T1	2.0	41 x 41	

Standard length = 6m

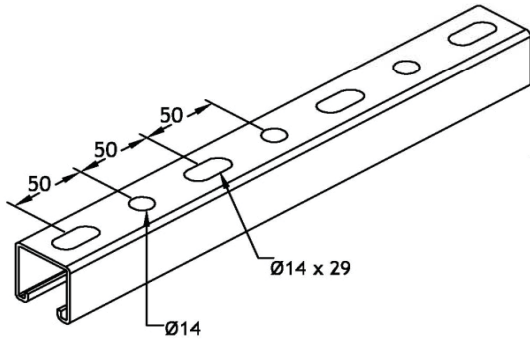

DSSB series	Material Thickness	dimension	Mass kg/m
FS100T2	2.5	41 x 41	
FS102T2	2.0	41 x 41	

Standard length = 6m

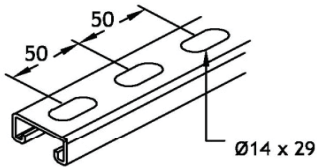

DSSB series	Material Thickness	dimension	Mass kg/m
FS300T1	2.5	22 x 41	
FS302T1	2.0	22 x 41	

Standard length = 6m

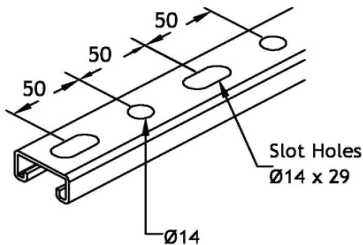

DSSB series	Material Thickness	dimension	Mass kg/m
FS300T2	2.5	22 x 41	
FS302T2	2.0	22 x 41	

Standard length = 6m

Standard Length : 6 Meter

CABLE TRAY

FLEXISTRUT

DSSB

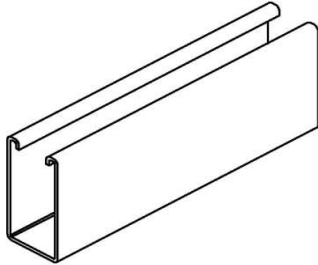

DSSB series	Material Thickness	dimension	Mass kg/m
FS500	2.0	62 x 41	

Standard length = 6m

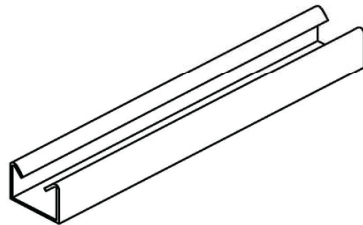
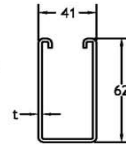

DSSB series	Material Thickness	dimension	Mass kg/m
UC200	2.0	30 x 41	

Standard length = 3m only

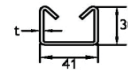

CONCRETE INSERT

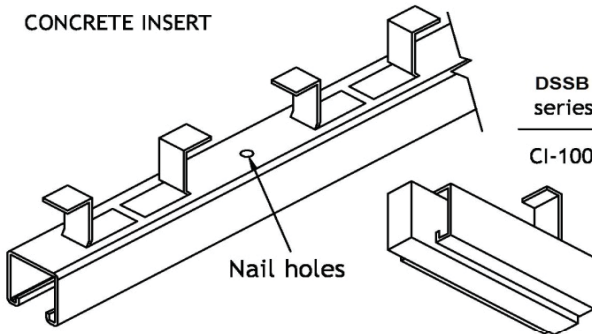

DSSB series	Material Thickness	dimension	Mass kg/m
CI-100	2.5	41 x 78	

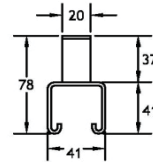

CONCRETE INSERT

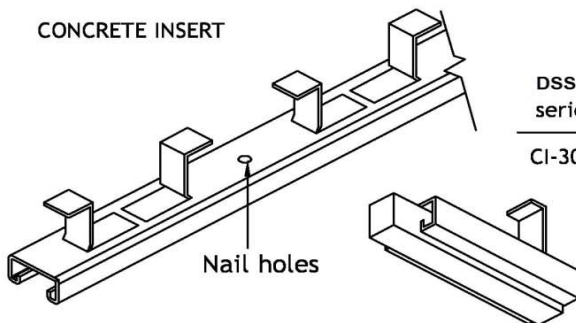

DSSB series	Material Thickness	dimension	Mass kg/m
CI-300	2.5	41 x 59	

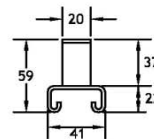

Standard Length : 6 Meter

FLEXISTRUT

DSSB

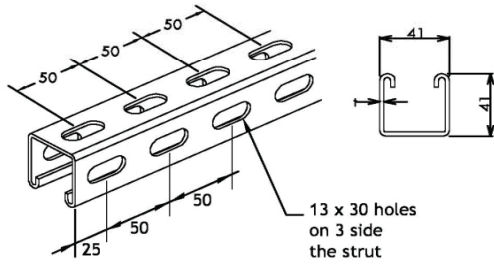

DSSB series	Material Thickness	Dimension	Mass kg/m
FS100T3	2.5	41 x 41	
FS102T3	2.0	41 x 41	

Standard length = 6m

Standard Length : 6 Meter

CABLE TRAY

CANTILEVER ARM

DSSB

CANTILEVER ARM - CA

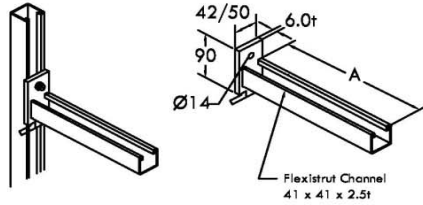

DSSB series	L	Weight (kg)
CA 200	200	
CA 250	250	
CA 300	300	
CA 350	350	
CA 400	400	
CA 500	500	

CANTILEVER ARM - CH

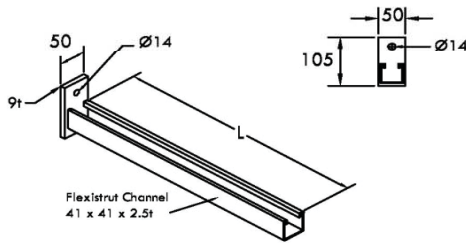

DSSB series	L	Weight (kg)
CH 300	300	
CH 350	350	
CH 400	400	
CH 500	500	
CH 550	550	
CH 600	600	
CH 700	700	

CANTILEVER ARM - CE

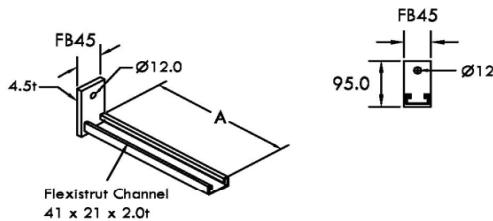

DSSB series	L	Weight (kg)
CE 100	100	
CE 200	200	
CE 250	250	
CE 300	300	
CE 400	400	

CANTILEVER ARM - CH

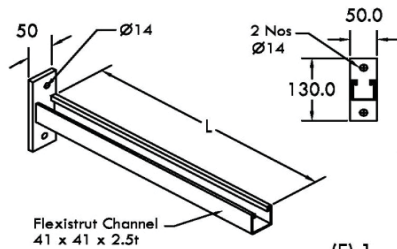

DSSB series	L	Weight (kg)	Design Uniform Load kN
CH 300	300	1.1	2.80
CH 350	350	1.3	2.3
CH 450	450	1.4	1.82
CH 500	500	1.5	1.50
CH 550	550	1.8	1.32
CH 600	600	2.1	1.11
CH 700	700	2.4	1.04

CANTILEVER ARM

DSSB

HEAVY DUTY CANTILEVER ARM - CJ Type

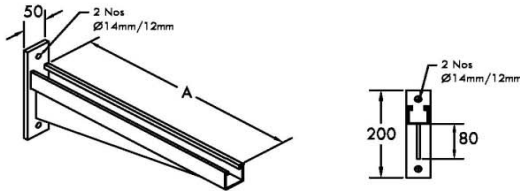

DSSB series	L	Weight (kg)
CJ500	500	
CJ600	600	
CJ700	700	
CJ800	800	
CJ900	900	

CANTILEVER ARM - CB Type

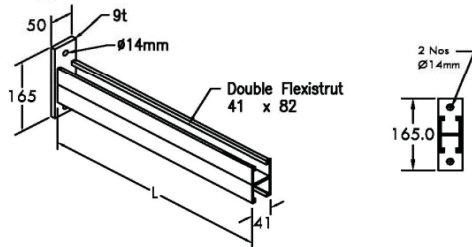

DSSB series	L	Weight (kg)
CB 600	600	
CB 700	700	
CB 800	800	

CANTILEVER ARM - CC Type

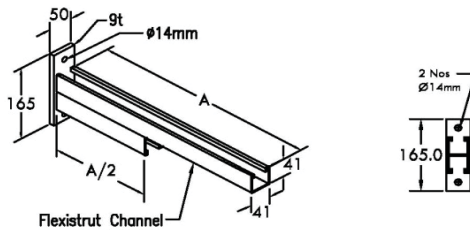

DSSB series	L	Weight (kg)
CC 600	600	3.1
CC 700	700	3.5
CC 800	800	3.9
CC 850	850	4.1
CC 950	950	4.5

CANTILEVER ARM - CD Type

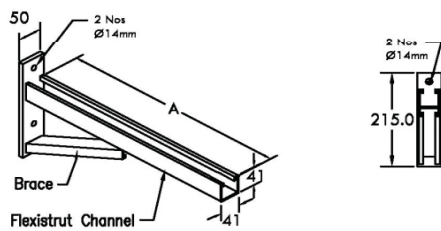

DSSB series	L	Weight (kg)
CD 600	600	
CD 700	700	
CD 800	800	
CD 900	900	

CANTILEVER ARM - CE Type

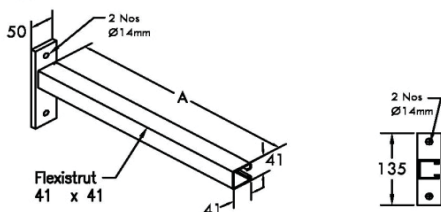

DSSB series	L	Weight (kg)
CE 600	600	
CE 700	700	
CE 800	800	
CE 900	900	

CABLE TRAY

VERTICAL SUPPORT BRACKET

DSSB

VERTICAL SUPPORT BRACKET- RIGHT

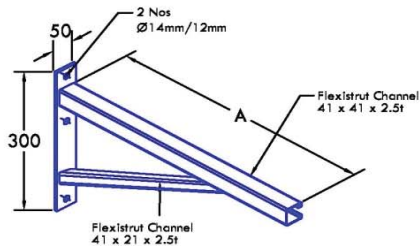

DSSB series	L	Weight (kg)
VSBR-300	300	
VSBR-350	350	
VSBR-400	400	
VSBR-450	450	
VSBR-550	550	
VSBR-600	600	
VSBR-700	700	

VERTICAL SUPPORT BRACKET- LEFT

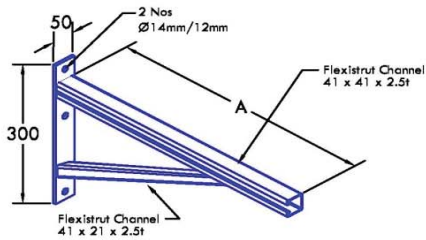

DSSB series	L	Weight (kg)
VSBL-300	300	
VSBL-350	350	
VSBL-400	400	
VSBL-450	450	
VSBL-550	550	
VSBL-600	600	
VSBL-700	700	

CABLE TRAY

CANTILEVER ARM

DSSB

HEAVY DUTY

CANTILEVER ARM - CL

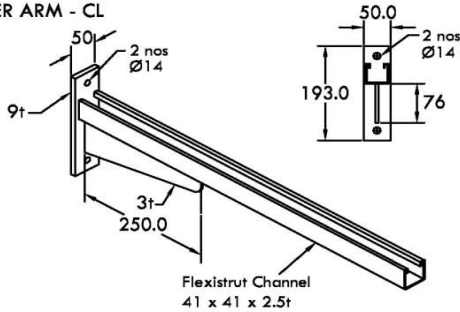

DSSB series	L	Weight (kg)
CL500	500	
CL600	600	
CL700	700	
CL800	800	

SWIVEL CANTILEVER ARM - CK

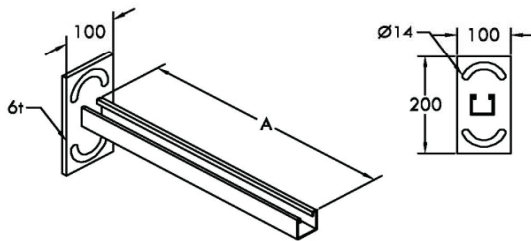

DSSB series	L	Weight (kg)
CK200	200	
CK300	300	
CK400	400	
CK500	500	

Double End arm - CFA1

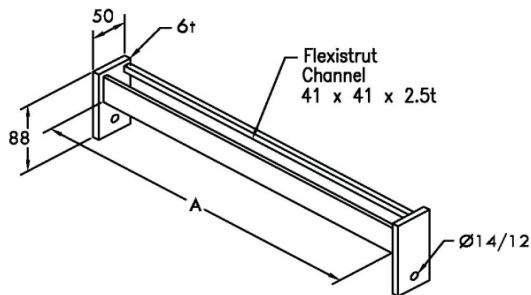

DSSB series	L	Weight (kg)
CFA1-250	250	
CFA1-400	400	
CFA1-550	550	
CFA1-600	600	
CFA1-700	700	
CFA1-900	900	

Double End arm - CF

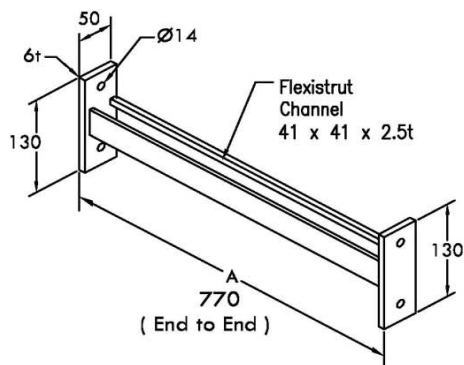

DSSB series	L	Weight (kg)
CF 500	500	
CF 600	600	
CF 700	700	
CF 800	800	
CF 900	900	

VERTICAL PIECES

DSSB

Vertical Piece

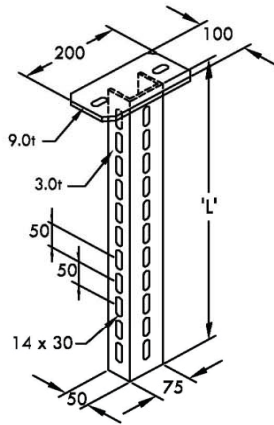

DSSB series	Size (L)	Weight (kg)
VPD/400	400	
VPD/600	600	
VPD/1000	1000	
VPD/1200	1200	

Two Side Vertical Piece

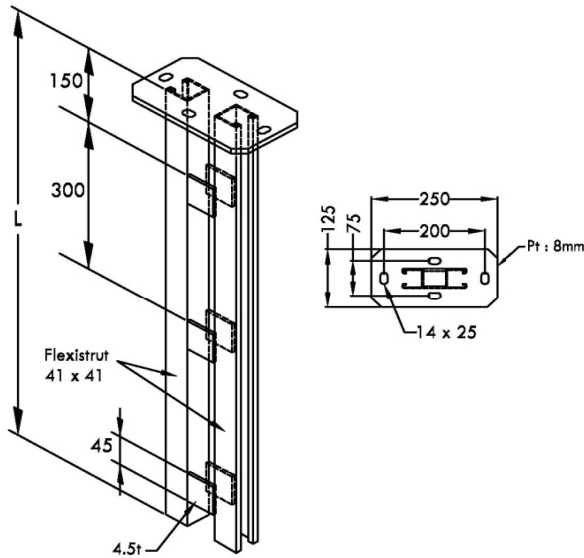

DSSB series	Size (L)	Weight (kg)
VPE/400	400	
VPE/600	600	
VPE/1000	1000	
VPE/1200	1200	

CABLE TRAY

VERTICAL PIECES

DSSB

Vertical Piece - VPA

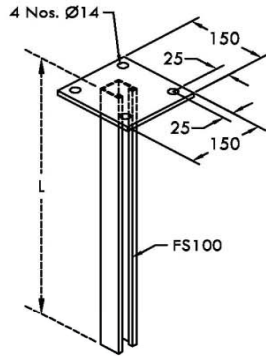

DSSB series	Size (L)	Weight (kg)
VPA-900	900	
VPA-1200	1200	
VPA-1500	1500	
VPA-2000	2000	

Vertical Piece - VPB

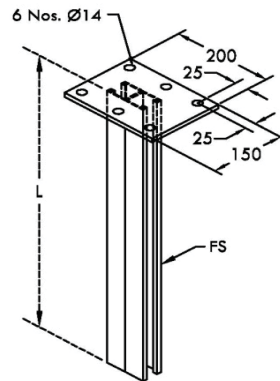

DSSB series	Size (L)	Weight (kg)
VPB-1500	1500	
VPB-2000	2000	
VPB-2500	2500	
VPB-3000	3000	

Vertical Piece - VPC

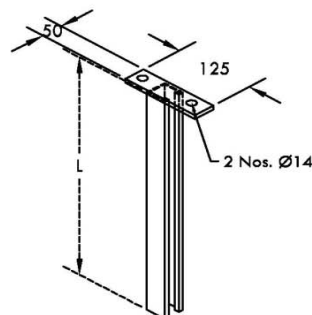

DSSB series	Size (L)	Weight (kg)
VPC-500	500	
VPC-700	700	
VPC-900	900	

CABLE TRAY

INSERT, CLOSURE, END CAPS

DSSB

Metal Closure Strip

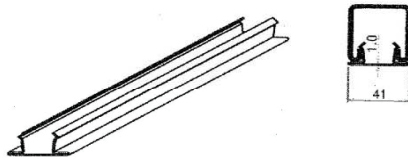

DSSB707

Weight : 0.70kg/m

Plastic Closure Strip

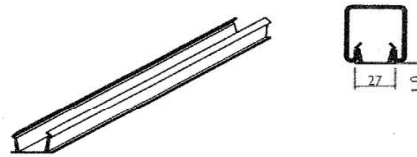

DSSB6151

Weight : 0.07kg/m

Insert Length m	Weight/100 kg	Max. Allowable Point Load kN	Min. Space Between Point Loads mm	Max. Allowable Uniform Loads kN/m
3	864.8	8.9	305	29.2
6	1729.6	8.9	305	29.2

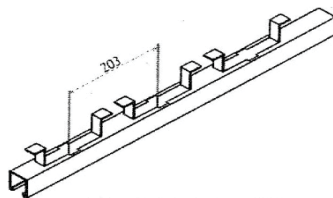

(When used for sprinkler system only)

DSSB349 CS/EC

- Use channel nuts design for DSSB 450 Channel.
- DSSB656 end cap used when distance to first anchor is upto 51mm
- DSSB653 enc cap used when end distance to first anchor is over 51mm
- Nail or anchor onsets to forms every 406mm to 610mm
- Includes closure and end caps unless otherwise requested

End cap for Concrete insert

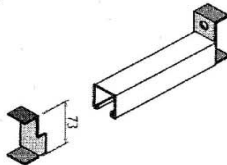

For use with DSSB349 when the distance from the end to the first tab is greater than 50mm

DSSB653

Weight : 6.4kg / 100



Material : 1.9 Electro-Galvanized Steel

DSSB655, DSSB930, DSSB2580, DSSB2585

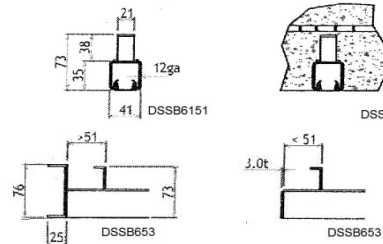

- Use channel nuts designed for DSSB450 channel

End cap for Concrete insert



For use with DSSB349 when the distance from the end to the first tab is greater than 50mm or less.

DSSB653

Weight : 3.6kg / 100

End caps

Art No:	Use With	"A"	Weight / 100 kg
DSSB2580	DSSB 150	2 7/6	7.3
DSSB655	DSSB 200	1 5/8	4.5
DSSB2582	DSSB 210	1 5/8	4.5
DSSB930	DSSB 500	13/16	1.8

POST BASES

DSSB

DSSB8013

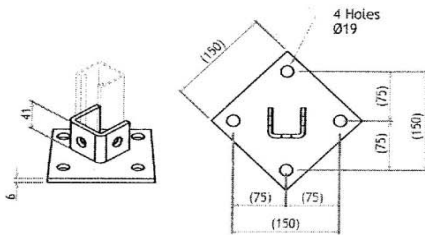

DSSB 8033

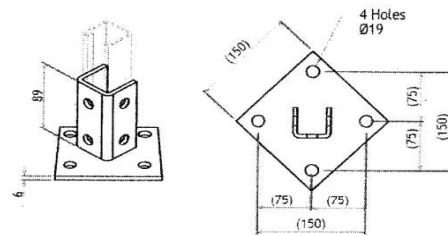

DSSB 8029

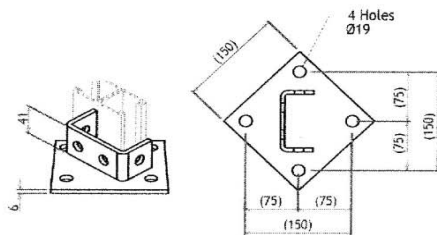

DSSB 8064

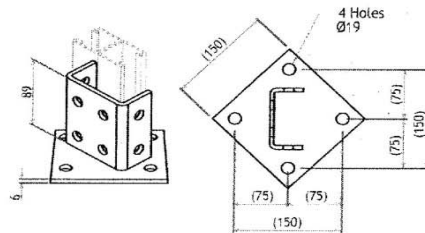

DSSB 8014

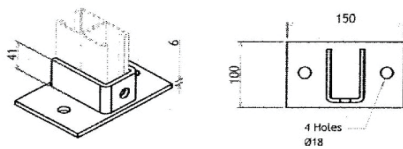

CABLE TRAY

PIPE / CONDUIT CLAMPS

DSSB

DSSB1000

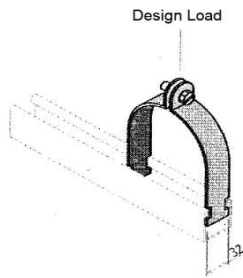

PIPE CLAMP FOR THIN WALL CONDUIT (E.M.T)

Pipe Size in	O.D Size mm	Thickness mm	Weight/100 kg	Design Load kN
3/8	14.7	1.5	4.1	1.8
1/2	17.9	1.5	5.0	1.8
3/4	23.4	1.5	5.4	1.8
1	29.5	1.9	6.8	2.7
1 1/4	38.4	1.9	8.2	2.7
1 1/2	44.2	2.7	13.2	3.6
2	55.8	2.7	15.0	3.6
2 1/2	73.0	2.7	18.1	3.6
3	88.9	2.7	21.3	3.6
3 1/2	101.6	3.0	28.1	4.4
4	114.3	3.0	30.4	4.4

Finish : Electro galvanized.
Slotted hex head screw and nut included

DSSB1100

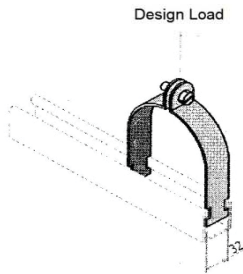

PIPE CLAMP FOR RIGID STEEL CONDUIT

Pipe Size in	O.D Size mm	Thickness mm	Weight/100 kg	Design Load kN
3/8	17.1	1.5	4.5	1.8
1/2	21.3	1.5	5.0	1.8
3/4	26.7	1.5	6.8	1.8
1	33.4	1.9	7.7	2.7
1 1/4	42.2	1.9	8.6	2.7
1 1/2	43.8	2.7	13.2	3.6
2	60.3	2.7	15.4	3.6
2 1/2	73.0	2.7	18.1	3.6
3	88.9	2.7	21.3	3.6
3 1/2	101.6	3.0	28.1	4.4
4	114.3	3.0	30.4	4.4
5	141.3	3.0	36.3	4.4
6	168.3	3.4	46.3	4.4
8	219.1	3.4	59.0	4.4

Finish : Electro galvanized.
Slotted hex head screw and nut included

DSSB1300

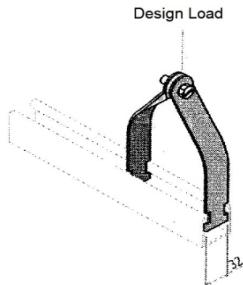

UNIVERSAL CLAMPS FOR RIGID OR THINWALL CONDUIT

Pipe Size in	Thickness mm	Weight/100 kg	Design Load kN
1/2	1.5	4.5	1.8
3/4	1.5	5.0	1.8
1	1.5	5.4	1.8
1 1/4	1.9	8.2	2.7
1 1/2	1.9	9.1	2.7
2	1.9	10.0	2.7

Finish : Electro galvanized.
Slotted hex head screw and nut included

PIPE / CONDUIT CLAMPS

DSSB

DSSB1200

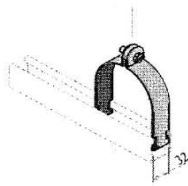

Finish : Electro galvanized.
Slotted hex head screw and nut included
When order add pipe size to art number
(e.g DSSB1000-3/4

DSSB1200 6.4mm TO 22.2
DSSB1200 25.4mm TO 41.3
DSSB1200 44.5mm TO 95.3
DSSB1200 98.4mm TO 139.7
DSSB1200 142.9mm TO 219.1

PIPE CLAMPS FOR O.D TUBING

O.D Size mm	Weight / 100 kg	Design Load kN	O.D Size mm	Weight / 100 kg	Design Load kN
6.4	3.6	400	111.1	29.9	1000
9.5	3.6	(1.8)	114.3	30.4	(4.4)
12.7	4.1		117.5	31.8	
15.9	4.5		120.7	32.7	
19.1	5.0		123.8	33.1	
22.2	5.4		127.0	33.6	
25.4	6.4	600	130.2	34.5	
28.6	6.8	(2.7)	133.4	34.9	
31.8	7.3		136.5	35.4	
34.9	7.7		139.7	35.8	
38.3	8.2		142.9	39.9	
41.3	8.6		146.1	40.8	
44.5	13.2	800	149.2	41.7	
47.6	12.7	(3.36)	152.4	42.8	
50.5	14.1		155.6	43.5	
54.0	14.5		158.8	44.5	
57.2	15.0		161.9	44.9	
60.3	15.4		165.1	45.4	
63.5	15.9		168.3	46.3	
66.7	16.8		171.5	47.2	
69.9	17.2		174.6	48.1	
73.0	18.1		177.8	49.0	
76.2	18.6		181.0	49.9	
79.4	19.5		184.2	50.8	
82.6	20.4		187.3	51.7	
85.7	20.9		190.5	52.6	
88.9	21.3		193.7	53.1	
92.1	25.4	1000	196.9	54.0	
95.3	26.3	(4.4)	200.0	54.9	
98.4	27.2		203.2	55.8	
101.6	28.1		206.4	56.7	
114.8	28.1		209.6	57.2	
108.0	29.0		212.7	58.1	
			215.9	58.5	
			219.1	59.0	

DSSB3126

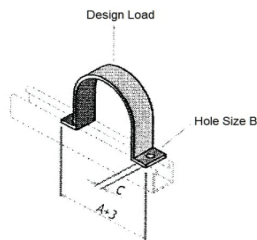

Hardware sold separately.
When order add pipe size to art number (e.g DSSB3126-3/4)

SINGLE PIECE PIPE STRAP

Nom. Pipe Size		"A" mm	"B" mm	"C" mm	Thickness mm	Weight / 100 kg	Design Load kN
73.0		73.0				10.4	
79.4		79.4				11.8	500
85.7		85.7	7.1	11.1	(3.2)	14.1	(2.2)
95.3		95.3				15.9	
98.4		98.4				17.7	
146.1		146.1				42.6	
158.8		158.8				51.7	
174.6		174.6				60.3	1000
187.3		187.3	11.1	17.5	(6.4)	68.9	(4.4)
200.0		200.0				79.8	
228.6		228.6				89.8	
254.0		254.0				102.1	

90° ANGLE FITTINGS

DSSB

DSSB2715

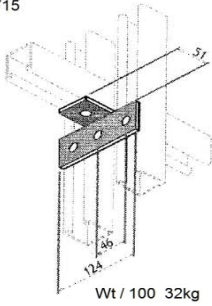

Wt / 100 32kg

DSSB2622

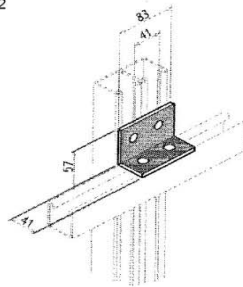

Wt / 100 34kg

DSSB2713

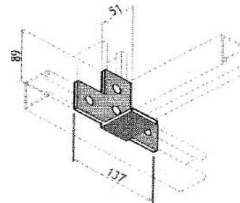

Wt / 100 48kg

DSSB2716R

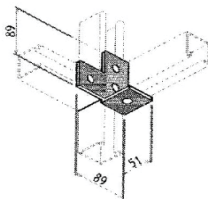

Wt / 100 36kg

DSSB2716L

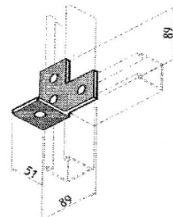

Wt / 100 36kg

DSSB2748

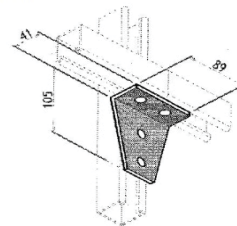

Wt / 100 48kg

DSSB2746

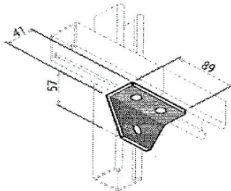

Wt / 100 32kg

DSSB2927

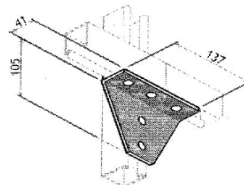

Wt / 100 70kg

DSSB2614

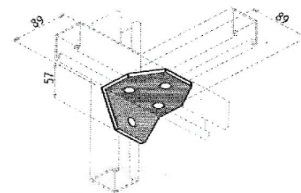

Wt / 100 47kg

DSSB2752R

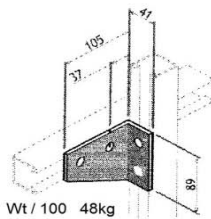

Wt / 100 48kg

DSSB2752L

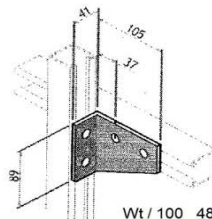

Wt / 100 48kg

DSSB2615

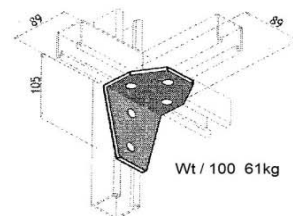

Wt / 100 61kg

CABLE TRAY

90° ANGLE FITTINGS

DSSB

DSSB2144

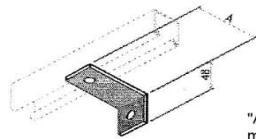

	"A" mm	Weight / 100 kg
DSSB2144A	75	22.2
DSSB2144B	88	24.5
DSSB2144C	100	27.7

DSSB2921

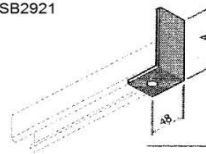

	"A" mm	Weight / 100 kg
DSSB921A	98	27.7
DSSB921B	149	38.1
DSSB921C	200	48.5
DSSB921D	250	59.0

DSSB2806A (WITH KNOCKOUT 2 SIDE)
DSSB2806 (WITHOUT KNOCKOUT 2 SIDE)

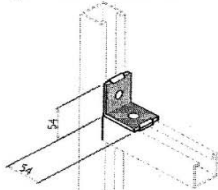

Wt / 100 18kg

DSSB2049

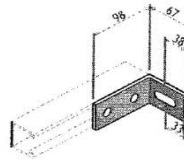

Wt / 100 30kg

DSSB2605

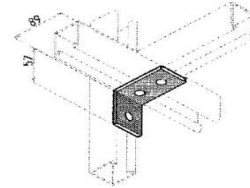

Wt / 100 26kg

DSSB2764

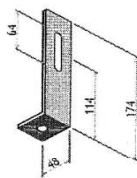

Wt / 100 85kg

DSSB2606

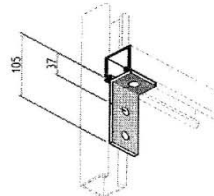

Wt / 100 26kg

DSSB2745

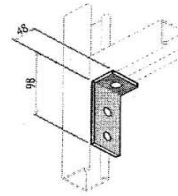

Wt / 100 26kg

DSSB2607

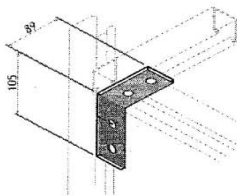

Wt / 100 35kg

DSSB2720R

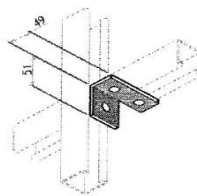

Wt / 100 25kg

DSSB2720L

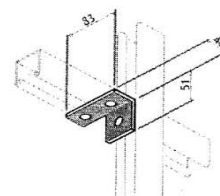

Wt / 100 25kg

90° ANGLE FITTINGS

DSSB

DSSB2603

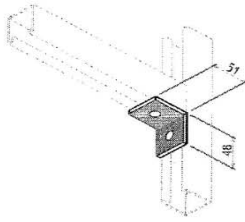

Wt / 100 17kg

DSSB2604

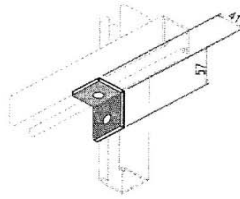

Wt / 100 17kg

ANGLE, WING SHAPE FITTINGS, U-SHAPE

DSSB

DSSB2689

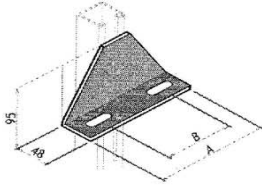

Art No:	"A" mm	"B" mm	Weight/100 kg
AM689A	168.3	101.6	86.2
AM689B	219.1	152.4	109.8

DSSB2113

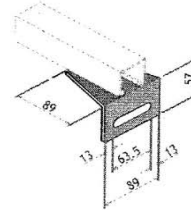

Wt/100 44kg

DSSB4373

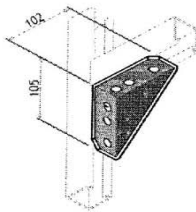

Wt/100 61kg

DSSB4821

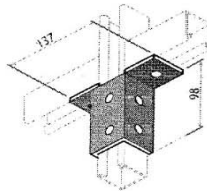

Wt/100 48kg

DSSB3756

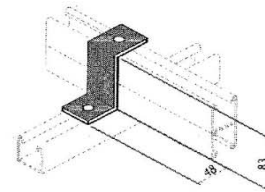

Wt/100 32kg

DSSB3611

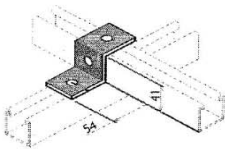

Wt/100 25kg

DSSB3928

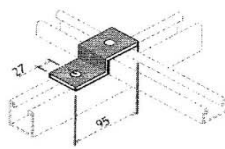

Wt/100 21kg

DSSB3601

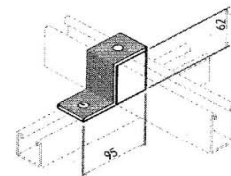

Wt/100 30kg

DSSB3721

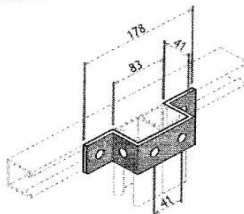

Wt/100 48kg

DSSB4631

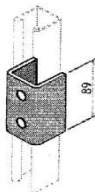

Wt/100 58kg

DSSB4645

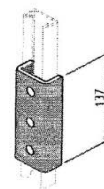

Wt/100 59kg

CABLE TRAY

FLAT PLATE FITTINGS

DSSB

<p>DSSB1744</p> <p>Wt / 100 32kg</p>	<p>DSSB1750</p> <p>Wt / 100 48kg</p>	<p>DSSB1190</p> <p>Wt / 100 68kg</p>
<p>DSSB1714</p> <p>Wt / 100 36kg</p>	<p>DSSB1712</p> <p>Wt / 100 48kg</p>	<p>DSSB1925</p> <p>Wt / 100 32kg</p>
<p>DSSB1747</p> <p>Wt / 100 48kg</p>	<p>DSSB1854</p> <p>Wt / 100 67kg</p>	<p>DSSB1822</p> <p>Wt / 100 80kg</p>
<p>DSSB1112</p> <p>Wt / 100 109kg</p>		

CABLE TRAY

FLAT PLATE FITTINGS

DSSB

DSSB1619

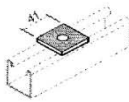

Bolt Size	Hole Size	Weight / 100 kg	
8mm	8.7mm	8.2	DSSB1619-8
10mm	11.1mm	8.2	DSSB1619-10
12mm	14.3mm	7.7	DSSB1619-12
16mm	17.5mm	7.3	DSSB1619-16
20mm	20.6mm	6.8	DSSB1619-20

DSSB1504

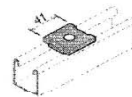

Bolt Size	Hole Size	Weight / 100 kg	
8mm	8.7mm	8.2	DSSB1504-8
10mm	11.1mm	8.2	DSSB1504-10
12mm	14.3mm	7.7	DSSB1504-12

DSSb1620

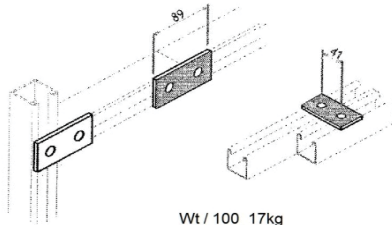

Wt / 100 17kg

DSSB1602

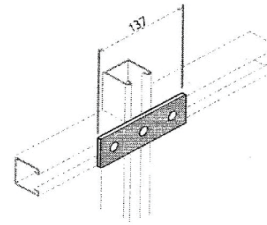

Wt / 100 25kg

DSSB1618

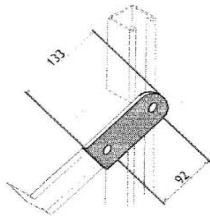

Wt / 100 25kg

DSSB1617

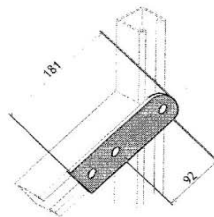

Wt / 100 34kg

DSSB1888

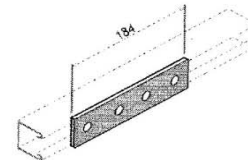

Wt / 100 135kg

DSSB1621

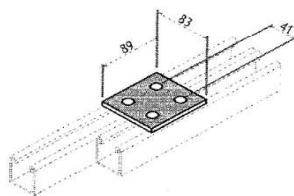

Wt / 100 33kg

DSSB1718

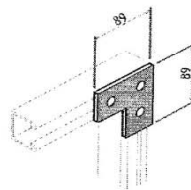

Wt / 100 26kg

DSSB1750A

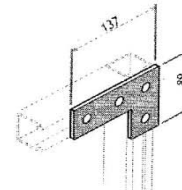

Wt / 100 36kg

CABLE TRAY

ANGLE, Z-SHAPE, U-SHAPE, WING FITTINGS

DSSB

DSSB2624

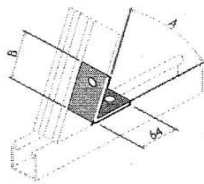

Wt/100 26kg

"A" Degree	"B" mm	
82.5°	81	DSSB2624A
75°	81	DSSB2624B
67.5°	79	DSSB2624C
60°	79	DSSB2624D
52.5°	78	DSSB2624E
45°	79	DSSB2624F
37.5°	76	DSSB2624G

DSSB2633

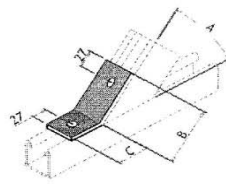

"A" Degree	"B" mm	"C" mm	
75°	91	43	DSSB2633A
45°	76	59	DSSB2633B
30°	83	52	DSSB2633C

DSSB5616

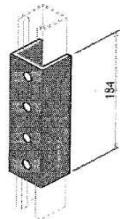

Wt/100 120kg

DSSB4922 R or L

R = As shown
L = Opposite hand

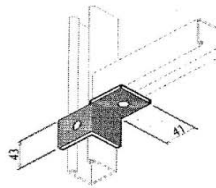

Wt/100 27kg

DSSB4117

R = As shown
L = Opposite hand

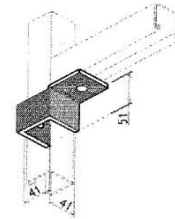

Wt/100 34kg

DSSB3613

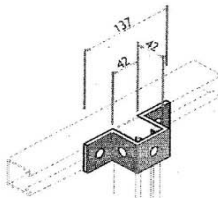

Wt/100 40kg

DSSB3929

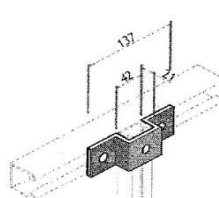

Wt/100 32 kg

DSSB3648

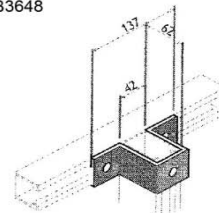

Wt/100 49 kg

DSSB3679

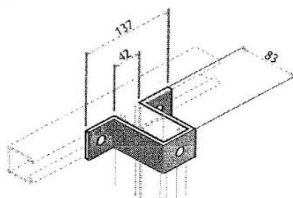

Wt/100 58 kg

DSSB4227

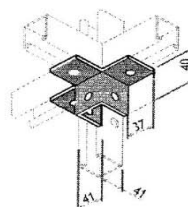

Wt/100 24kg

DSSB4223

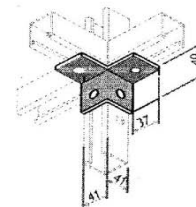

Wt/100 16kg

CABLE TRAY

BEAM CLAMPS

DSSB

DSSB 7651 T1

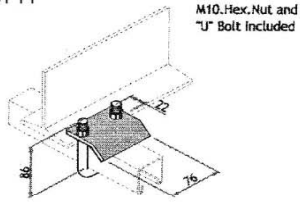

- . Design Load Each 4.4Kn
- . Use in Pairs Only
- . Form use with Beams up to 19.0mm Thick
- Flanges and Channels AM200, AM210, AM450, AM500, AM4502T3 and AM5002T3

Wt/100 38 kg

DSSB 7651 T2

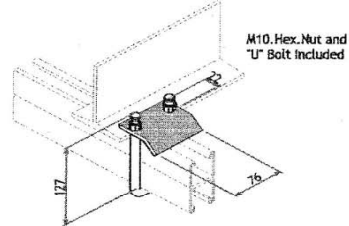

- . Design Load Each 4.4Kn
- . Use in Pairs Only
- . Form use with Beams up to 19.0mm Thick
- Flanges and Channels AM2002T3, AM2102T3 and AM150

Wt/100 42 kg

DSSB 7855-1

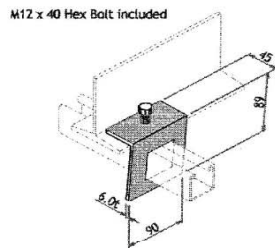

Wt/100 41 kg

DSSB 7684

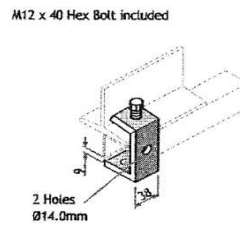

Wt/100 43 kg

End Cap for Single Strut
DSSB 6153-1

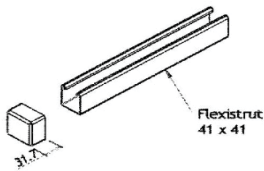

Material : Orange PVC

End Cap for Double strut
DSSB 6153-2

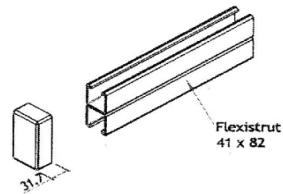

Material : Orange PVC

CABLE TRAY

BEAM CLAMPS

DSSB

DSSB 7656 T1

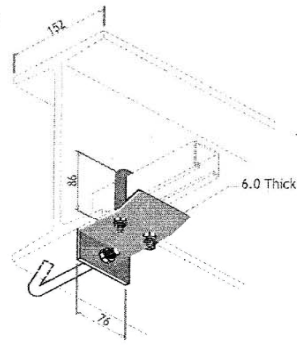

. Included "J" Bolt "U" Bolt and Hex.Nut
Wt/100 61 kg

DSSB 7656 T2

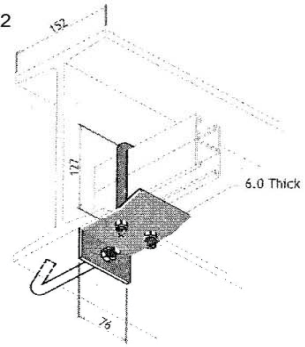

. Included "J" Bolt "U" Bolt and Hex.Nut
Wt/100 65 kg

DSSB 7657 T1

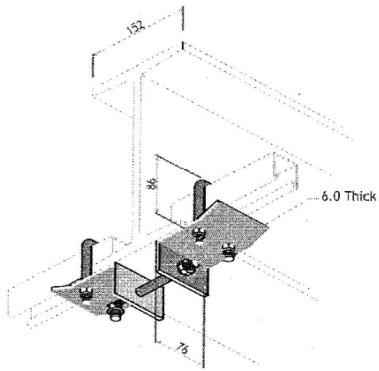

. Included Center Rod, "U" Bolt and Hex.Nut
Wt/100 127 kg

DSSB 7657 T2

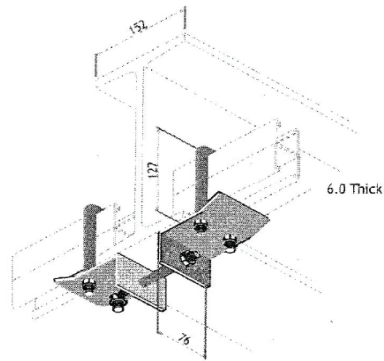

. Included Center Rod, "U" Bolt and Hex.Nut
Wt/100 135 kg

SAMPLE INSTALLATION



Pengkalan Industry 132/33/11 kV Substation, Perak

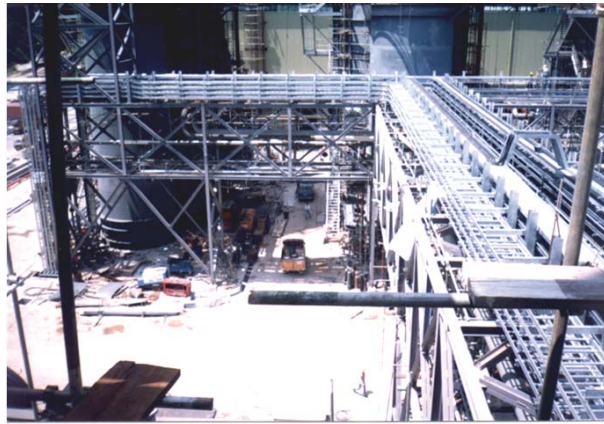

Lumut Power Plant, Perak



Serdang 275/132 kV Substation

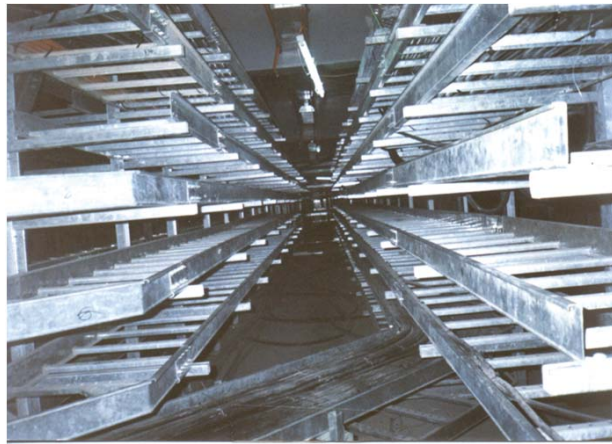

120MW IPP Sabah, Sepangar Bay, Sabah.



Pasir Panjang 132kV Substation.



Lumut Power Plant, Perak

INSTALLATION

A. Reference List : Project for the last 5 years (Local)

PROJECT	CONTRACTORS
1 Lenggeng 500/275kV & Olak Lampit 275kV Ext	Areva / SPM
2 Rantau / Pontian Substation	AMBC Transmission
3 Matedeng, Selangau, Petian Substation	Siemens Malaysia
4 DRI, Banting	San Kong Engineering Sdn Bhd
5 Biomass Power Plant, Sandakan	San Kong Engineering Sdn Bhd
6 M378 PCPP D30 MOPU	INE Technologies
7 Petronas Fertilizer Kedah (PFK) Gurun, Kedah	J&M Power
8 EPCC of APCST , Melaka	Enersea Resources Sdn. Bhd
9 Nhon Trach 2	Siemens AG
10 North Pnom Peng S/S & Kampong Cham S/S, Cambodia	Pestech
11 Petronas Lubricant International Melaka Lube Blending Plant	Handal Engineering
12 Sun Power	ABB

B. Reference List : Project for the last 5 years (Overseas)

PROJECT	CONTRACTORS
1 Shangri-La Hotel, maldives	Keppel
2 Mathanel	Keppel
3 Kazakhstan Shipyard - Piperack	Oglaend
4 Dynamic Producer	Oglaend
5 Derrick Lay Barge - KS Benoi	Keppel
6 Armada Perdana (OYO)	Oglaend
7 Armada Perdana (OYO)	Keppel
8 Brunei	Oglaend
9 Jurong Port	Oglaend
10 Halfdan Phase IV - SMOE	Oglaend

Note: We have also been supplying to other companies which we do not have any records of their sites.

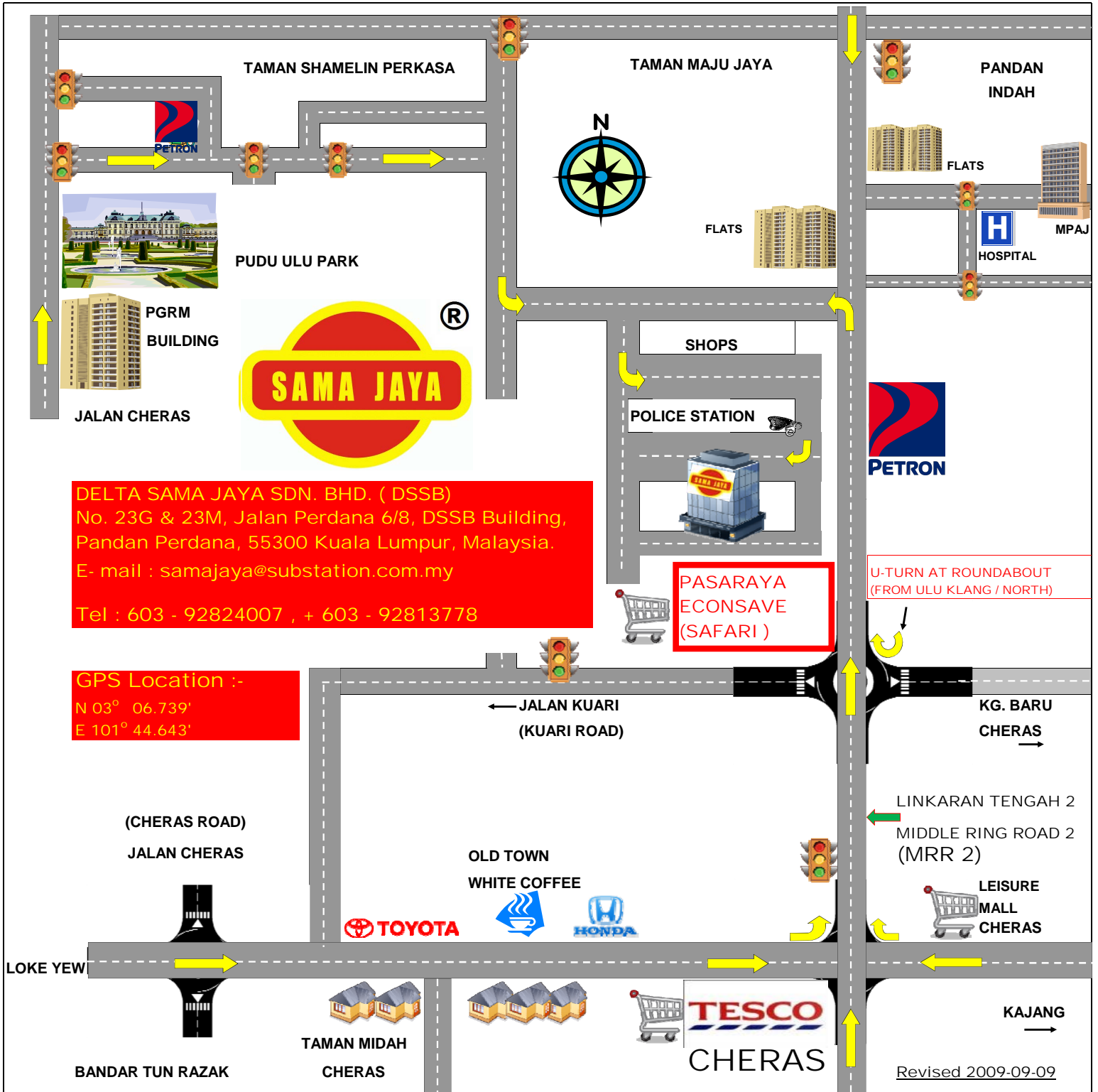

DELTA SAMA JAYA SDN. BHD. (DSSB)
 No. 23G & 23M, Jalan Perdana 6/8, DSSB Building,
 Pandan Perdana, 55300 Kuala Lumpur, Malaysia.
 E- mail : samajaya@substation.com.my
 Tel : 603 - 92824007 , + 603 - 92813778

GPS Location :-
 N 03° 06.739'
 E 101° 44.643'

**PASARAYA
 ECONSAVE
 (SAFARI)**

U-TURN AT ROUNDABOUT
 (FROM ULU KLANG / NORTH)

(CHERAS ROAD)
 JALAN CHERAS

← JALAN KUARI
 (KUARI ROAD)

KG. BARU
 CHERAS →

LINKARAN TENGAH 2
 MIDDLE RING ROAD 2
 (MRR 2)

LEISURE
 MALL
 CHERAS

LOKE YEW

BANDAR TUN RAZAK

TAMAN MIDAH
 CHERAS

**TESCO
 CHERAS**

KAJANG →

Revised 2009-09-09