

# CABLE LAYING ACCESSORIES



**Tab 10**

## CABLE JACK with SHAFT

Item Code	Capacity	Shaft
DSSB-CLA-CJACK-10	10 tons	Hollow
DSSB-CLA-CJACK-10-SS	10 tons	Solid
DSSB-CLA-CJACK-10(C)	10 tons	Hollow
DSSB-CLA-CJACK-10-SS(C)	10 tons	Solid

\*(C) - with certificate

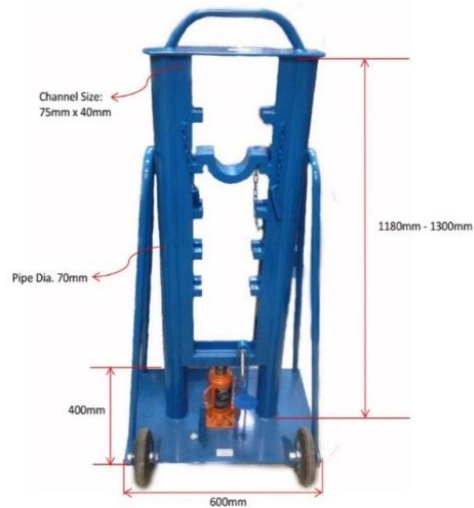

## CABLE ROLLER (HANGING TYPE)

Item Code	Size:
DSSB-CLA-CRLL-HNG6	Small
DSSB-CLA-CRLL-HNG8	Big-1
DSSB-CLA-CRLL-HNGB	Big-2

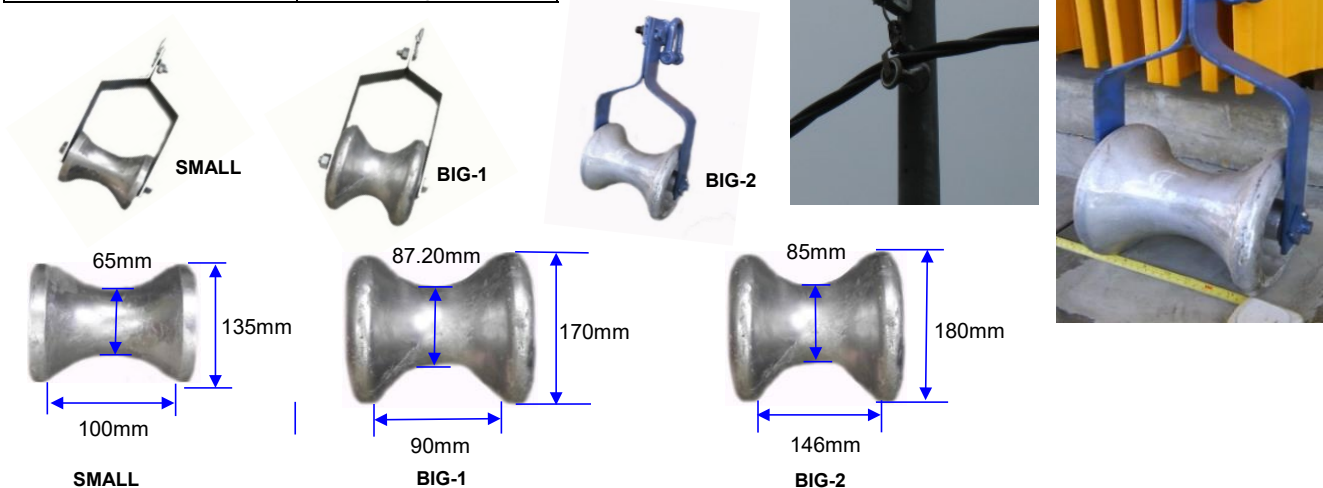

### CABLE ROLLER (GROUND TYPE)

Item Code	Type	Suitable Cable OD (mm)
DSSB-CLA-CRLL-GRD6	Standard	0 - 100 mm $\varnothing$
DSSB-CLA-CRLL-GRD8	Heavy Duty	0 - 80 mm $\varnothing$



### CABLE ROLLER (TRIPLE CORNER TYPE)

Item Code
DSSB-CLA-CRLL-HCDL-24



### CABLE ROLLER (ANGLE TYPE)

Item Code	Suitable Cable OD (mm)
DSSB-CLA-CRLL-HCDL-31	0 - 180 mm $\varnothing$





## PULLING GRIPS (CABLE SOCK) TG SERIES



TG- used for Medium Load of cable

Item Code	Area	Cable Dia.	Max.Load
	(mm <sup>2</sup> )	(mm)	(ton)
DSSB-CLA-PUCS-TG050-24		12-15	2.04
DSSB-CLA-PUCS-TG062-24		15-18	2.54
DSSB-CLA-PUCS-TG075-24		18-25	3.08
DSSB-CLA-PUCS-TG100-24		25-37	4.35
DSSB-CLA-PUCS-TG150-24	Single 50	37-50	7.43
DSSB-CLA-PUCS-TG200-24	70-240	50-63	8.39
DSSB-CLA-PUCS-TG250-24	3x70-120	63-75	11.11
DSSB-CLA-PUCS-TG300-24	3x150-240	75-88	11.11
DSSB-CLA-PUCS-TG350-24	3x300 over	88-101	14.06
DSSB-CLA-PUCS-TG400-24	3x300 over	101-114	14.51
DSSB-CLA-PUCS-TG450-24	3x300 over	114-127	15.42
DSSB-CLA-PUCS-TG500-24	3x300 over	127-152	16.32

## PULLING GRIPS (CABLE SOCK) SG SERIES

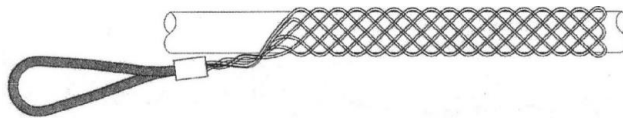

Item Code	Cable Dia. (mm)	Max.Load (ton)
DSSB-CLA-PUCS-SG075A	18-25mm	1.13
DSSB-CLA-PUCS-SG100A	25-32mm	1.569
DSSB-CLA-PUCS-SG125A	32-37mm	1.81
DSSB-CLA-PUCS-SG150A	37-50mm	1.81
DSSB-CLA-PUCS-SG200A	50-63mm	1.81
DSSB-CLA-PUCS-SG250A	63-75mm	1.81
DSSB-CLA-PUCS-SG300A	75-88mm	1.81
DSSB-CLA-PUCS-SG350A	88-101mm	1.81
DSSB-CLA-PUCS-SG400A	101-114mm	2.18
DSSB-CLA-PUCS-SG450A	114-127mm	2.27
DSSB-CLA-PUCS-SG500A	127-152mm	2.36
DSSB-CLA-PUCS-SG600A	152-177mm	2.45

## MEASURING WHEEL

Item Code	Distance	Wheel Size
DSSB-CLA-MW/KEN-320	10km	32cm
DSSB-CLA-WM-10K	10km	16cm



CLA-MW/KEN-320



CLA-WM-10K

## HEAVY DUTY SWIVEL JOINT

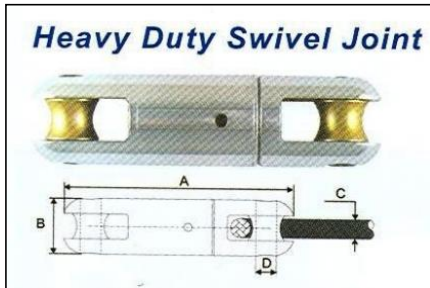

Item Code	W.L.L (ton)	Breaking load (ton)	Dimension (mm)				Weight (kg)
			A	B	C	D	
DSSB-CLA-HDS-3TON	3	9	137 mm	32 mm	13 mm	13 mm	0.5 kg
DSSB-CLA-HDS-5TON	5	15	152 mm	39 mm	17 mm	14 mm	1.0 kg
DSSB-CLA-HDS-6.7TON	6.7	20	160 mm	42 mm	18 mm	16 mm	1.1 kg
DSSB-CLA-HDS-8.3TON	8.3	25	177 mm	45 mm	20 mm	16 mm	1.2 kg
DSSB-CLA-HDS-16.7TON	16.7	50	228 mm	60 mm	25 mm	24 mm	3.4 kg

## LIGHT DUTY SWIVEL JOINT

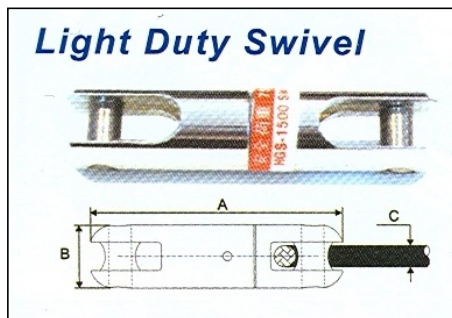

Item Code	W.L.L (ton)	Breaking Load (ton)	Dimension (mm)			Weight (kg)
			A	B	C	
DSSB-CLA-DHGS-750	0.35	1.2	60 mm	18 mm	9 mm	0.07 kg
DSSB-CLA-DHGS-1500	0.75	2.5	85 mm	26 mm	14 mm	0.2 kg
DSSB-CLA-DHGS-3000	1	3	90 mm	24 mm	12 mm	0.35kg
DSSB-CLA-DHGS-3500	1.5	4.5	105 mm	36 mm	20 mm	0.5 kg
DSSB-CLA-DHGS-5000	2	7.2	140 mm	30 mm	13 mm	0.6 kg
DSSB-CLA-DHGS-8000	4	12	150 mm	38 mm	16 mm	1.0 kg

## ALUMINIUM BREAK-AWAY SWIVELS

### Aluminium 7/8 inches (22.2 mm) Diameter Break-Away Swivel

Item Code	Break Point kgs	Break Point Lbs.	Colour Code
DSSB-CLA-BAS-AL154	154	340	White
DSSB-CLA-BAS-AL204	204	450	Orange
DSSB-CLA-BAS-AL272	272	600	Yellow
DSSB-CLA-BAS-AL364	364	800	Blue
DSSB-CLA-BAS-AL454	454	1000	Green
DSSB-CLA-BAS-AL544	544	1200	Red

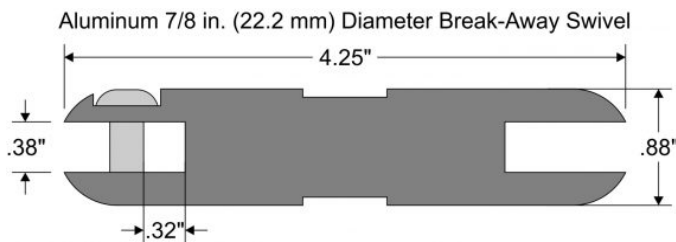

## STEEL BREAK-AWAY SWIVELS

### Steel 5/8 inches (15.9mm) Diameter Break-Away Swivel

Item Code	Break Point kgs	Break Point Lbs.	Colour Code
DSSB-CLA-BAS-ST91	91	200	Orange/White
DSSB-CLA-BAS-ST100	100	220	Red/White
DSSB-CLA-BAS-ST134	134	295	Green/White
DSSB-CLA-BAS-ST154	154	340	White
DSSB-CLA-BAS-ST181	181	400	Blue/White
DSSB-CLA-BAS-ST190	190	420	Yellow/White
DSSB-CLA-BAS-ST197	197	435	Voilet/White
DSSB-CLA-BAS-ST204	204	450	Orange
DSSB-CLA-BAS-ST226	226	500	Voilet
DSSB-CLA-BAS-ST272	272	600	Yellow
DSSB-CLA-BAS-ST317	317	700	Brown

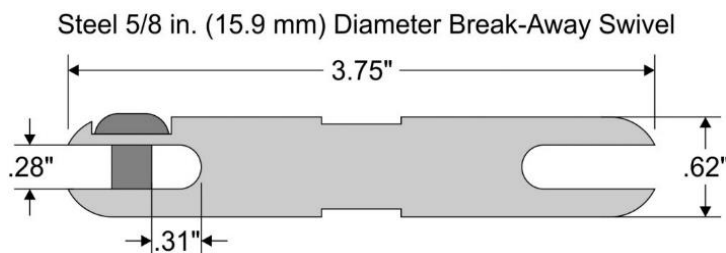

## RATCHET PULLER

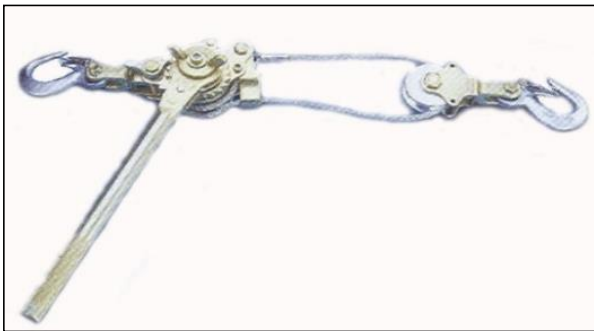

Model	Capacity
DSSB-CLA-RP-1000	1 Ton
DSSB-CLA-RP-1500	1.5 Ton
DSSB-CLA-RP-2000	2 Ton
Double Wire 5m/m x 2300	

## FIBREGLASS CABLE PULLER

MADE FROM HIGH TENSILE AND DURABLE POM (Polyoxymethylene) PLASTIC

Item Code	Dia	Length	Safety Load	Breaking Strength
DSSB-CLA-FCP 0415	4.5mm	15m	80 kgs	135 kgs
DSSB-CLA-FCP 0420	4.5mm	20m		
DSSB-CLA-FCP 0430	4.5mm	30m		
DSSB-CLA-FCP 0450	4.5mm <td 50m			

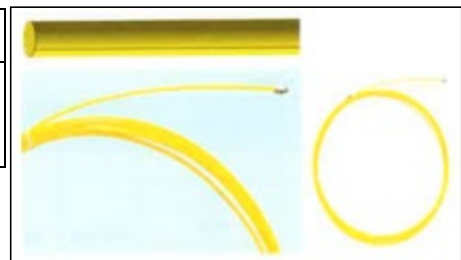

THREE COMPOSITE MATERIAL PULLERS INTO A STRONGEST WIRE GUIDER

Model No. DSCFP 0815 - DSCFP 08100 are made from  $\phi 1.2\text{mm}$  steel wire robe coated with composite material pullers.

Item Code	Dia	Length		Safety Load	Breaking Strength
DSSB-CLA-FCP 0815	7mm	15m		650 kgs	950 kgs
DSSB-CLA-FCP 0830	7mm	30m			
DSSB-CLA-FCP 0850	7mm	50m			
DSSB-CLA-FCP 08100	7mm	100m			
DSSB-CLA-FCP 0830T	7mm	30m	with carrier		
DSSB-CLA-FCP 0850T	7mm	50m	tube		

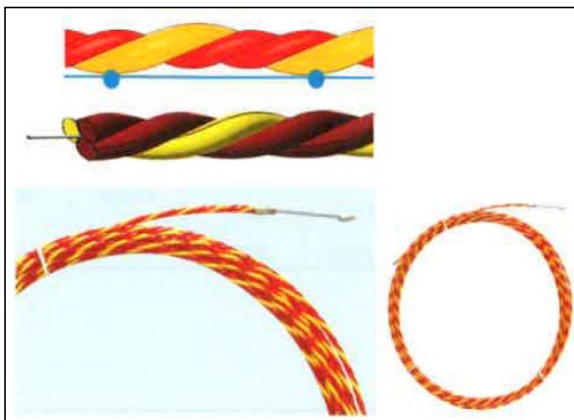



## CONDUIT SNAKE

Item Code	Dia	Length
DSSB-CLA-CS300-11	11mm	300m
DSSB-CLA-CS300-14	14mm	300m
DSSB-CLA-CS150-12	12mm	150m
DSSB-CLA-CS100-08	8mm	100m
DSSB-CLA-FLEX650	6.7mm	150m



### Conduit Snake

#### Description

Conduit Snake has range of continuous fibreglass duct rod.

Diameter 8mm, 11mm and 14mm have detachable pulling eye as standard

It is made from pultruded fibreglass strands jacketed with 2mm tough polypropylene coating to give a unique combination of strength and durability.

#### Accessories

- ~ use for conducting and cleaning of underground cable
- ~ both end can be attach with accessories
- ~ made in fibreglass, high elastic
- ~ easy to operate

#### Flexitrace

##### Description

Flexitrace come with copper cable inside the complete length of rod.

Operator need to attached the Cable Locator's Transmitter to the flexi-rod to provide an Active Frequency to the rod and we can trace the alignment and depth of the rod.

The detection depth is up to 3m.

The rod diameter is much more smaller compare to flexi-rod, have to handle with care to prevent the rod broken.

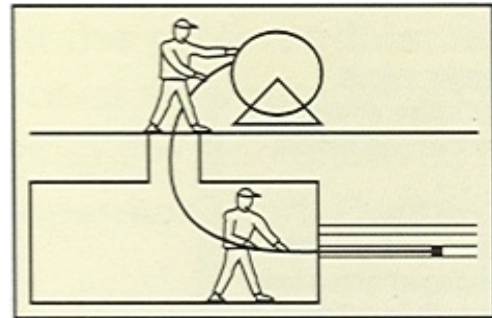

## PIPE CLEANING TOOLS

### PIPE CLEANING MANDRELS

Pipe Cleaning Mandrels are manufactured from Polypropylene and are fitted with steel rotating fixing eyes each end.



ITEM CODE	DIA
DSSB-CLA-PCM-80	80mm

### PIPE CLEANING BRUSHES

Pipe cleaning brushes synthetic bristle type Cylindrical Duct Brushes are fitted with steel rotating fixing eyes each end.

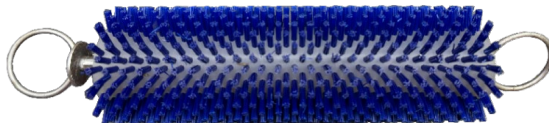

ITEM CODE	DIA	LENGTH
DSSB-CLA-PCB	95mm	3000 mm



## WIRE GRIP (COME ALONG TONG) (MADE: JAPAN) WITH PATENTED TWIST GRIP

Wire Grip (for Copper Cable, Covered Cable, Guy Wire, Wire Rope, Trolley Cable)

Item Code	Capacity WLL (ton)	Min. Cable	Max. Cable	Jaw Length	Weight
DSSB-CLA-WG/C-NEW-SD	1	2.6mm	15mm	*	0.6kg
DSSB-CLA-WG/C-SD-S	1	3mm	13mm	50mm	0.6kg
DSSB-CLA-WG/C-10KN	1	5mm	22mm	70mm	1.1kg
DSSB-CLA-WG/C-20KN	2	5mm	22mm	90mm	1.5kg
DSSB-CLA-WG/C-20KN-W	2	5mm	22mm	90mm	1.5kg
DSSB-CLA-WG/C-MIGHTY20	2	5mm	28mm	120mm	1.9kg
DSSB-CLA-WG/C-LARGE20	2	16mm	35mm	120mm	2.1kg
DSSB-CLA-WG/C-30KN	3	6mm	22mm	90mm	1.7kg
DSSB-CLA-WG/C-LARGE30	3	18mm	35mm	120mm	2.4kg
DSSB-CLA-WG/C-40KN	4	8mm	28mm	140mm	3.3kg



[Click Here For Product Flyer](#)

Wire Grip (for Bare Aluminum, ACSR, ACSS, AAC, Copper Cable)

Item Code	Capacity WLL (ton)	Min. Cable	Max. Cable	Jaw Length	Weight
DSSB-CLA-WG/B-AL-10KN	1	5mm	22mm	70mm	1.1kg
DSSB-CLA-WG/B-AL-20KN	2	5mm	22mm	90mm	1.5kg
DSSB-CLA-WG/B-AL-MIGHTY20	2	5mm	28mm	120mm	1.9kg
DSSB-CLA-WG/B-AL-LARGE20	2	16mm	35mm	120mm	2.1kg
DSSB-CLA-WG/B-AL-30KN	3	6mm	22mm	90mm	1.7kg
DSSB-CLA-WG/B-AL-LARGE30	3	18mm	35mm	120mm	2.4kg
DSSB-CLA-WG/B-AL-50KN	5	18mm	36mm	180mm	4.6kg
DSSB-CLA-WG/B-AL-60KN	6	28mm	46mm	220mm	7.0kg



[Click Here For Product Flyer](#)

Wire Grip (for Aerial Bundled Cable (Conductor))

Item Code	Capacity (ton)	Min. Cable	Max. Cable	Jaw Length
DSSB-ABC-WG/A-S	0.35	4 x 16mm	4 x 35mm	80mm
DSSB-ABC-WG/A-M	1	4 x 25mm	4 x 95mm	160mm
DSSB-ABC-WG/A-L	1.8	4 x 95mm	4 x 150mm	180mm

\* More Details can be found at the <https://www.abcaccessoriesmalaysia.com>



[Click Here For Product Flyer](#)

## RAILWAY GRIP (COME ALONG TONG) (MADE: JAPAN)

Item Code	Capacity (ton)	Min. Cable	Max. Cable	Jaw Length
DSSB-ABC-Trolley-20	2	5mm	22mm	90mm
DSSB-ABC-Trolley-30	3	5mm	22mm	90mm
DSSB-ABC-Trolley-60	6	8mm	28mm	140mm
DSSB-ABC-Feeder-MT20	2	5mm	28mm	120mm
DSSB-ABC-Feeder-LG30	3	17mm	35mm	120mm
DSSB-ABC-AL-50KN	5	18mm	28mm	180mm
DSSB-ABC-AL-60KN	6	28mm	28mm	220mm

\* More Details can be found at the <https://www.rail.com.my>



## GRIPS (MADE: TAIWAN)

### Wire Grip (Also for copper messenger wire)

Item Code	Capacity (ton)	Conductor Diameter (mm)	Weight (kg)
DSSB-CLA-WG1000T	1 Ton	2.6-15mm	0.6 kg

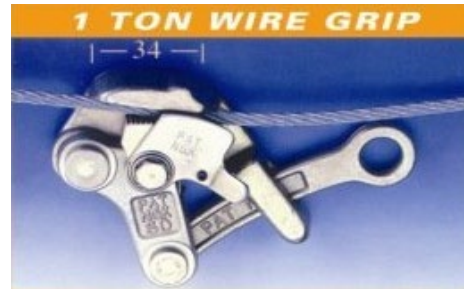

### Wire Grip (aka Mighty Grip)

Item Code	Capacity (ton)	Conductor Diameter (mm)	Weight (kg)
DSSB-CLA-WG2000T	2 Ton	4-22mm	1.3 kg

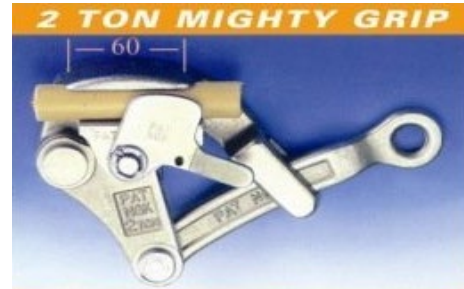

### Wire Grip (Also for Insulated Copper & Aluminium Conductor)

Item Code	Capacity (ton)	Conductor Diameter (mm)	Weight (kg)
DSSB-CLA-WG3000T	3 Ton	16-32mm	2.5 kg



## WEB STRAP PULLERS

### Web Strap (N)

Item Code	Capacity (ton)	Strap Size	Min. L	Handle. L	Weight
DSSB-ABC-N-1000	1 Ton	32 x 2 mm	400 mm	370 mm	3.2 kg
DSSB-ABC-N-1500	1.5 Ton	32 x 2 mm	400 mm	460 mm	3.5 kg



### Web Strap (NP)

Item Code	Capacity (ton)	Strap Size	Min. L	Handle. L	Weight
DSSB-ABC-NP-1000	1 Ton	32 x 2 mm	420 mm	370 mm	3.4 kg
DSSB-ABC-NP-1500	1.5 Ton	32 x 2 mm	420 mm	460 mm	3.5 kg



### Web Strap (NEX)

Item Code	Capacity (ton)	Strap Size	Min. L	Handle. L	Weight
DSSB-ABC-NEX-1000	1 Ton	32 x 2 mm	480 mm	370 mm	3.7 kg
DSSB-ABC-NEX-1500	1.5 Ton	32 x 2 mm	480 mm	460 mm	3.9 kg

Convertible type with 3 hooks.



### Web Strap (NEX-H)

Item Code	Capacity (ton)	Strap Size	Min. L	Handle. L	Weight
DSSB-ABC-NEX-1000	1 Ton	32 x 2 mm	480 mm	370 mm	3.7 kg
DSSB-ABC-NEX-1500	1.5 Ton	32 x 2 mm	480 mm	460 mm	3.9 kg

For hot-line (live-line) work.

Convertible Type with 3 hooks.



**DYNAMOMETER-TENSION METER**

# Dynamometer

TENSION METER



Item Code	Capacity	Weight	A	B-Body	C	D	Weight
DSSB-CLA-DYMTM5-0.5TON	5kN	0.9 kg	160mm	75mm	90mm	20mm	0.9kg
DSSB-CLA-DYMTM10-1TON	10kN	1.0 kg	190mm	75mm	90mm	25mm	1.0kg
DSSB-CLA-DYMTM20-2TON	20kN	1.1 kg	190mm	75mm	90mm	25mm	1.1kg
DSSB-CLA-DYMTM30-3TON	30kN	1.9 kg	240mm	75mm	95mm	35mm	1.9kg
DSSB-CLA-DYMTM50-5TON	50kN	2.6 kg	250mm	90mm	120mm	35mm	2.6kg
DSSB-CLA-DYMTM100-10TON	100kN	6.0 kg	350mm	110mm	140mm	50mm	6.0kg

- Compact, Lightweight, rugged construction
- Designed for line work.
- Accepts harsh field conditions(cold&heat)
- Graduated in kilonewtons (kN).
- Accuracy +/- 3% Full Scales.
- Both pulling eyes rotate 360 degrees.
- Optional maximum reading indicator pointer kit available for easy installation.
- Optional easily installed screw-on face with twin steel protective bars also available.
- Each tool is serial numbered and supplied in a heavy duty fabric case with calibration certificate.
- Available in sizes 5kN up to 100kN.

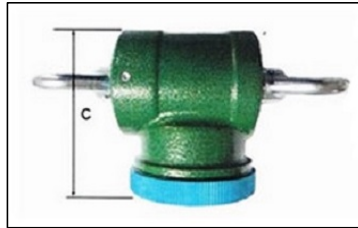
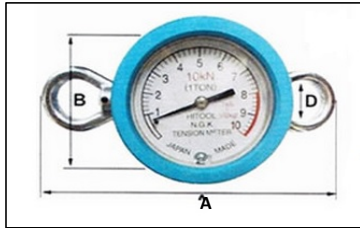

[Click Here For Product Flyer](#)



## CABLE PULLING LUBRICANT GEL - POLYWATER

Item Code	Weight
DSSB-CLA-CL/PW	5 gallons / 19 liter

- Clean drying and non-staining for less mess.
  - Water based and water washable.
  - Good Friction reducing properties.
  - Applies easily by pumping, or using the front end pack bag system.
  - Low Solids will not cement-in cables.
  - Evaporates after use. Nothing to soil hands or pollute environment.
  - Temperature stable. No waste due to phase separation.
  - Compatible with most cables, including polyethylene jackets.
  - Proven effectiveness through decades of worldwide use.
- **Temperature used range: -5°C to 33°C (20°F to 90°F)**
  - **Non-Flammable material.**
  - **Tested via IEEE 1210.**



**Polywater® GC** is general purpose, clear, clean, water-based, thixotropic gel lubricant recommended for all types of cable pulling, including verticals. *Environmentally safe and non-toxic.*

[Click Here For Product Flyer](#)

## CABLE LUBE GEL

Item Code	Weight
DSSB-CLA-CLG	5 gallons / 19 liter

- Compatible with a wide range of cable jacket. Including Polyethylene Jackets,
- Temperature stable. Does not liquify or get runny at high temperatures.
- Maximum Friction Reduction - For low cable pulling tension.
- High Cling Factor - Stay on cable Jacket during application.
- Clean and Non-Staining - Minimizes clean-up time.



[Click Here For Product Flyer](#)

## HDPE SOLID WALL CABLE PIPES - PN10

Item Code	Outside Dia.	Wall Thickness	Standard Length
DSSB-MSC-SWCP110R	110mm	8.1mm-9.1mm	6m/12m/100m
DSSB-MSC-SWCP160R	160mm	11.8mm-13.1mm	6m/12m
DSSB-MSC-SWCP200R	200mm	14.7mm-16.3mm	6m/12m
DSSB-MSC-SWCP250R	250mm	18.4mm-20.4mm	6m/12m



## PIPE FITTINGS



Straight Coupling



Sweep Bend



Plain Bend

## HDPE CORRUGATED PIPE (DOUBLE-WALL)

Item Code	Size (Ø)
DSSB-MSC-DWCP100R	100mm
DSSB-MSC-DWCP150R	150mm



\*\*\*other sizes/type available upon request

## HDPE CORRUGATED PIPE DOUBLE-WALL FITTINGS

ITEM CODE	End Cap Size (Ø)
DSSB-CLA-EC100	100
DSSB-CLA-EC150	150
DSSB-CLA-EC200	200
DSSB-CLA-EC225	225



Tee Joint



## HEAVY DUTY HIGH IMPACT RIGID CONDUIT

ITEM CODE	Size (mm)
DSSB-CLA-SH20	20
DSSB-CLA-SH25	25
DSSB-CLA-SH32	32
DSSB-CLA-SH40	40
DSSB-CLA-SH50	50

Colour : White / Orange

Length : 2.9m

Our Heavy Duty High Impact uPVC Conduit is manufactured from specially formulated high impact polyvinyl chloride in strict accordance to meet the requirement of

BS EN 61386-21:2004,  
MS 1534:PT.2:SEC.1:2002  
IEC 61386-21:2002

(Heavy Duty 4421)

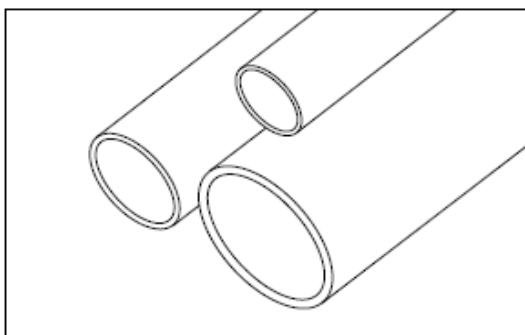

[Click Here For Product Flyer](#)

## CORRUGATED CONDUIT - FIRE RETARDANT

ITEM CODE	Size (mm)
DSSB-CLA-SCC20	20
DSSB-CLA-SCC25	25

Colour : White / Orange / Black

Coil : 50m

Our Corrugated Conduit is manufactured from specially formulated High Impact polyvinyl chlorida and comply to the requirement of

BS EN 61386-22:2008

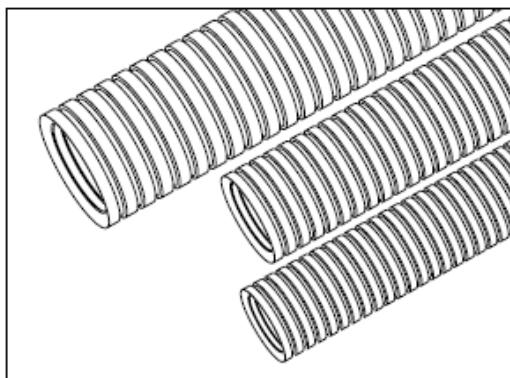

[Click Here For Product Flyer](#)



## CORRUGATED CONDUIT

ITEM CODE	Size (mm)	Coil/m
DSSB-CLA-PCC7*	7	300
DSSB-CLA-PCC10*	10	200
DSSB-CLA-PCC16	16	50
DSSB-CLA-PCC32	32	25
DSSB-CLA-PCC40	40	25
DSSB-CLA-PCC50	50	25

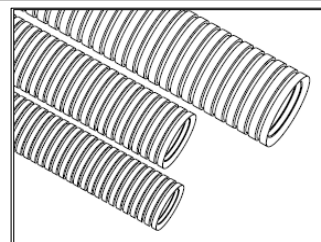

Colour : White / Black  
Black Only\*

Our Corrugated Conduit is produced from specially formulated excellent thermoplastic material to provide the highest flexibility.



## PIPE SPACER

Item Code	Spacer Hole Size (Max) mm	PVC Conduit For Telecommunication Cables. Approx. Size (Ø ID/OD) mm	HDPE Double Wall Corrugated Pipe Approx. Size (Ø ID/OD) mm	HDPE Solid Wall PN 10 Cable Pipe Approx. Size (Ø ID/OD) mm	UPVC Pressure Pipes PN 6/9 Class B/C. Size (Ø ID/OD) mm
DSSB-CLA-PS123D/P	123	100 / 107 (PVC)	100 / 120	90 / 110	100 / 115
DSSB-CLA-PS175D/P	175	136 / 160 (PE)	150 / 175	133 / 160	155 / 169
DSSB-CLA-PS210D/P	210	-	-	165 / 200	-
DSSB-CLA-PS100C/P	126	100 / 107 (PVC)	100 / 120	90 / 110	100 / 115
DSSB-CLA-PS150C/P	178	136 / 160 (PE)	150 / 175	133 / 160	155 / 169
DSSB-CLA-PS205B/P	205	-	-	165 / 200	-
DSSB-CLA-PS240B/P	240	-	200 / 235	166 / 200	200/218

### Technical Details:

- High Compression Strength
- Low Co-efficient of friction
- High Impact Strength
- High Hardness Level

### Product Features:

- Uniform Support to Weight of Pipe
- Chemical resistance
- Electrical Insulation
- Dimensional Stability
- Corrosion Protection
- Keeping various pipes separated
- Modular design
- Easy to assemble

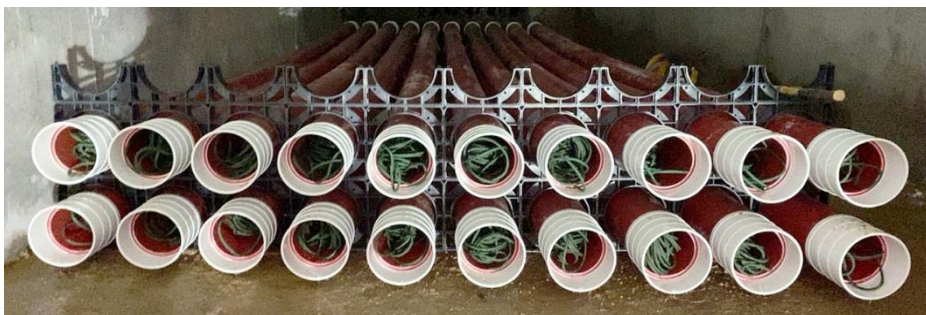
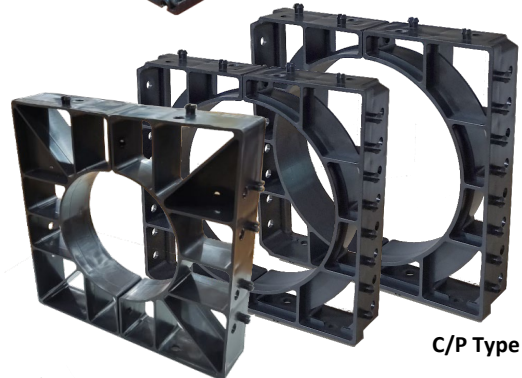
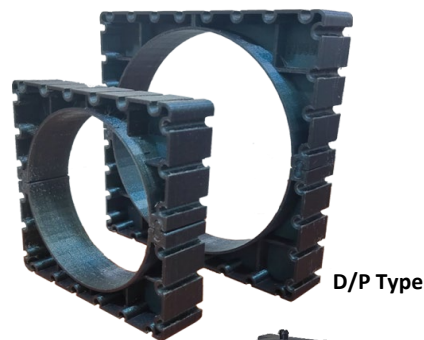

[Click Here For Product Flyer](#)

## TORQUE WRENCH

Item Code	Torque
DSSB-CLA-TORQUEWRNCH	40Nm - 210Nm

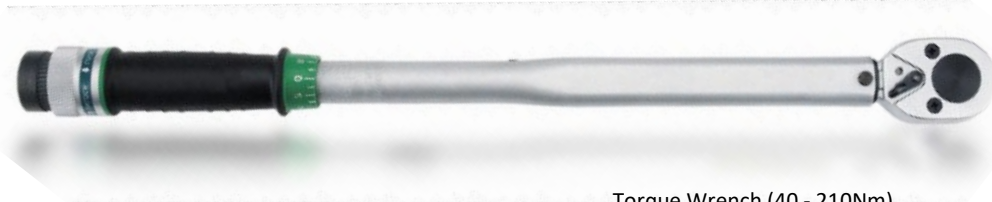

Torque Wrench (40 - 210Nm)

Build from *chrome vanadium steel hardened, tempered* and *satin chrome* for maximum corrosion protection. Twist torque dial with lock, prevent accidental down dialing damage. Comfortable rubber cushion grip. Packed in an easy carrying case and display sleeve.



Metric 6 Point Flank Socket :  
(From the right) 17mm, 19mm, 21mm, 22mm, 24mm, 27mm



Hex Bit Socket :  
(From the right) 6mm, 8mm, 10mm, 12mm



Torque Wrench (40 - 210Nm)  
Metric 6 Point Flank Socket : 17mm, 19mm, 21mm, 22mm, 24mm, 27mm  
Hex Bit Socket : 6mm, 8mm, 10mm, 12mm

# Delta Sama Jaya Sdn.Bhd.



**DELTA SAMA JAYA**  
[www.substation.com.my](http://www.substation.com.my)

We are constantly reviewing and updating our products,  
for the latest information please call us on (+603) 9281 3778  
or visit our website at: [www.substation.com.my](http://www.substation.com.my)